

HELLOMOTO

Introducing your new Motorola V360 GSM wireless phone. Here's a quick anatomy lesson.

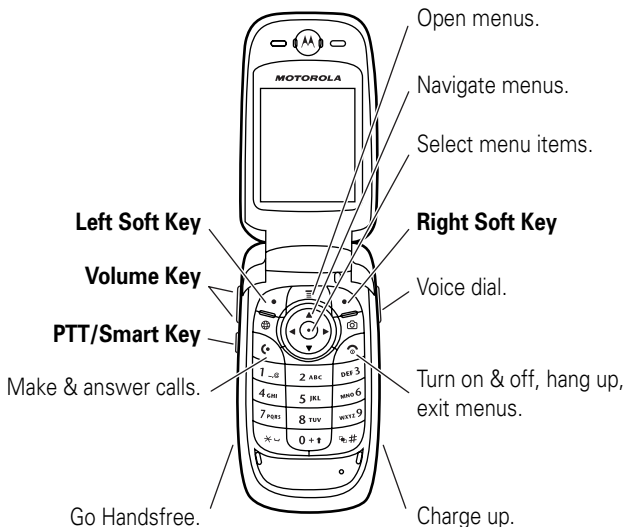

For Push to Talk (PTT) details, see page 57.

Certain mobile phone features are dependent on the capabilities and settings of your service provider's network. Additionally, certain features may not be activated by your service provider, and/or the provider's network settings may limit the feature's functionality. Always contact your service provider about feature availability and functionality. All features, functionality, and other product specifications, as well as the information contained in this user's guide are based upon the latest available information and are believed to be accurate at the time of printing. Motorola reserves the right to change or modify any information or specifications without notice or obligation.

MOTOROLA and the Stylised M Logo are registered in the US Patent & Trademark Office. The Bluetooth trademarks are owned by their proprietor and used by Motorola, Inc. under licence. Java and all other Java-based marks are trademarks or registered trademarks of Sun Microsystems, Inc. in the U.S. and other countries. All other product or service names are the property of their respective owners.

© Motorola, Inc. 2005.

The information contained in Motorola's user's guides is believed to be correct at the time of printing. Motorola reserves the right to change or modify any information or specifications without notice. The contents of Motorola's user's guides are provided "as is." Except as required by applicable law, no warranties of any kind, either express or implied, including, but not limited to, the implied warranties of merchantability and fitness for a particular purpose, are made in relation to the accuracy, reliability, or contents of this guide.

Caution: Changes or modifications made in the radio phone, not expressly approved by Motorola, will void the user's authority to operate the equipment.

While Products specifications and features may be subject to change without notice, we are making every possible effort to ensure that user manuals are updated on a regular basis to reflect product functionality revisions. However, in the unlikely event that your manual version does not fully reflect the core functionality of your product, please let us know. You may also be able to access up-to-date versions of our manuals in the consumer section of our Motorola web site, at <http://www.motorola.com>.

feature locator

main menu



Phonebook



Recent Calls

- Received Calls
- Dialed Calls
- Notepad
- Call Times *
- Call Cost *
- Data Times *
- Data Volumes *



Messages

- Create Message
- Email Msgs
- Message Inbox
- Voicemail
- Browser Msgs
- Info Services *
- Quick Notes
- Outbox
- Drafts
- MMS Template



Office Tools

- SIM Tool Kit Apps *
- Calculator
- Datebook
- Shortcuts
- Alarm Clock
- Dialing Services
 - Fixed Dial



Games & Apps



Web Access

- Browser
- Web Shortcuts
- Stored Pages
- History
- Go to URL
- Browser Setup
- Web Sessions *



Multimedia

- Pictures
- Camera
- Sounds
- Video Camera
- Videos



Bluetooth Link

- Handsfree
- Device History
- Setup



Settings

- (see next page)

* optional features

This is the standard main menu layout. Your phone's menu may be a little different.

settings menu



Personalize

- Home Screen
- Main Menu
- Skin
- Greeting
- Wallpaper
- Screen Saver



Ring Styles

- Style
- style Detail



Connection

- Sync
- USB Settings



Call Forward *

- Voice Calls
- Fax Calls
- Data Calls
- Cancel All
- Forward Status



In-Call Setup

- In-Call Timer
- Call Cost Setup *
- My Caller ID
- Talk and Fax
- Answer Options
- Call Waiting



Initial Setup

- Time and Date
- 1-Touch Dial
- Display Timeout
- Backlight
- TTY Setup *
- Scroll
- Language
- Brightness
- DTMF
- Master Reset
- Master Clear



Phone Status

- My Tel. Numbers
- Credit Info/Available *
- Active Line *
- Battery Meter
- Storage Devices
- Other Information



Headset

- Auto Answer
- Voice Dial



Car Settings

- Auto Answer
- Auto Handsfree
- Power-Off Delay
- Charger Time



Network

- New Network
- Network Setup
- Available Networks
- My Network List *
- Network Jingle *
- Call Drop Tone



Security

- Phone Lock
- Lock PTT Key
- Lock Application
- Fixed Dial
- Restrict Calls *
- Call Barring *
- SIM PIN
- New Passwords
- Certificate Mgmt *



PTT Settings

- PTT Service



Java Settings

- Java System
- Delete All Apps
- App Vibration
- App Volume
- App Backlight

* optional features

contents

feature locator	3
Safety Information	8
EU Conformance	16
Recycling Information	17
essentials	18
about this guide	18
SIM card	18
battery	19
turn it on & off	21
make a call	22
answer a call	22
your phone number	22
main attractions	23
take & send a photo	23
record video	25
MP3 audio player	26
cable connections	27
memory card	28
Bluetooth® wireless	31

basics	34
display	34
menus	37
text entry	39
volume	44
navigation key	44
external display	45
handsfree speaker	45
codes & passwords	45
lock & unlock phone	46
customize	47
ring style	47
time & date	48
wallpaper	48
screen saver	49
display appearance	49
answer options	50
calls	51
turn off a call alert	51
recent calls	51
redial	52
return a call	53
notepad	53
hold or mute a call	53
call waiting	54
caller ID	54
emergency calls	55
international calls	55
1-touch dial	55
voicemail	56
push to talk (PTT) calls	57

other features	62
advanced calling	62
phonebook	64
messages	68
personalizing	70
call times & costs	73
handsfree	74
data & fax calls	75
network	76
personal organizer	77
security	79
fun & games	79
SAR Data	82
index	84

Safety and General Information

IMPORTANT INFORMATION ON SAFE AND EFFICIENT OPERATION. READ THIS INFORMATION BEFORE USING YOUR PHONE.¹

Exposure To Radio Frequency (RF) Energy

Your phone contains a transmitter and a receiver. When it is ON, it receives and transmits RF energy. When you communicate with your phone, the system handling your call controls the power level at which your phone transmits.

Your Motorola phone is designed to comply with local regulatory requirements in your country concerning exposure of human beings to RF energy.

Operational Precautions

To assure optimal phone performance and make sure human exposure to RF energy is within the guidelines set forth in the relevant standards, always adhere to the following instructions.

External Antenna Care

If your phone has an external antenna, use only the supplied or Motorola-approved replacement antenna. Unauthorised antennas, modifications, or attachments could damage the phone and/or may result in non-compliance with local regulatory requirements in your country.

Do NOT hold the external antenna when the phone is IN USE. Holding the external antenna affects call quality and may cause the phone to operate at a higher power level than needed.

Phone Operation

When placing or receiving a phone call, hold your phone as you would a wireline phone.

Body-Worn Operation: Voice Communication

To maintain compliance with RF energy exposure guidelines, if you wear a phone on your body when transmitting voice communications, always place the phone in a Motorola-supplied or approved clip, holder, holster, case, or body harness for this phone, if available. Use of accessories not approved by Motorola may exceed RF energy exposure guidelines.

If you do not use one of the body-worn accessories approved or supplied by Motorola, and are not using the phone held in the normal use position, ensure the phone and its antenna are at least 2.5 centimetres (1 inch) from your body when transmitting.

Data Operation

When using any data feature of the phone, with or without an accessory cable, position the phone and its antenna at least 2.5 centimetres (1 inch) from your body.

Approved Accessories

Use of accessories not approved by Motorola, including but not limited to batteries, antennas, and convertible covers, may cause your phone to exceed RF energy exposure guidelines. For a list of approved Motorola accessories, visit our website at www.motorola.com.

RF Energy Interference/Compatibility

Note: Nearly every electronic device is susceptible to RF energy interference from external sources if inadequately shielded, designed, or otherwise configured for RF energy compatibility. In some circumstances your phone may cause interference.

Note: This device complies with Part 15 of the FCC Rules. Operation is subject to the following two conditions: (1) this device may not cause harmful interference, and (2) this device must accept any interference received, including interference that may cause undesired operation.

Facilities

Turn off your phone in any facility where posted notices instruct you to do so. These facilities may include hospitals or health care facilities that may be using equipment that is sensitive to external RF energy.

Aircraft

Turn off your wireless device whenever instructed to do so by airline staff. If your device offers a flight mode or similar feature, consult airline staff about use in flight. If your device offers a feature that automatically turns on the phone, then turn off this feature before boarding an aeroplane or entering an area where the use of wireless devices is restricted.

Medical Devices

Pacemakers

Pacemaker manufacturers recommend that a minimum separation of 15 centimetres (6 inches) be maintained between a handheld wireless phone and a pacemaker.

Persons with pacemakers should:

- ALWAYS keep the phone more than 15 centimetres (6 inches) from your pacemaker when the phone is turned ON.
- NOT carry the phone in the breast pocket.
- Use the ear opposite the pacemaker to minimise the potential for interference.
- Turn OFF the phone immediately if you have any reason to suspect that interference is taking place.

Hearing Aids

Some digital wireless phones may interfere with some hearing aids. In the event of such interference, you may want to consult your hearing aid manufacturer to discuss alternatives.

Other Medical Devices

If you use any other personal medical device, consult the manufacturer of your device to determine if it is adequately shielded from RF energy. Your physician may be able to assist you in obtaining this information.

Use While Driving

Check the laws and regulations on the use of phones in the area where you drive. Always obey them.

When using your phone while driving, please:

- Give full attention to driving and to the road. Using a phone may be distracting in certain circumstances. Discontinue a call if you can't concentrate on driving.
- Use handsfree operation, if available.
- Pull off the road and park before making or answering a call if driving conditions so require.

Responsible driving best practices can be found in the “Wireless Phone Safety Tips” at the end of this guide and/or at the Motorola website: www.motorola.com/callsmart.

Operational Warnings

For Vehicles With an Air Bag

Do not place a phone in the area over an air bag or in the air bag deployment area. Air bags inflate with great force. If a phone is placed in the air bag deployment area and the air bag inflates, the phone may be propelled with great force and cause serious injury to occupants of the vehicle.

Gas or Petrol Stations

Obey all posted signs with respect to the use of radio equipment in gas or petrol stations. Turn off your wireless device if instructed by authorised staff.

Potentially Explosive Atmospheres

Turn off your phone prior to entering any area with a potentially explosive atmosphere. Do not remove, install, or charge batteries in such areas. Sparks in a potentially explosive atmosphere can cause an explosion or fire resulting in bodily injury or even death.

Note: The areas with potentially explosive atmospheres referred to above include fuelling areas such as below decks on boats, fuel or chemical transfer or storage facilities, areas where the air contains chemicals or particles, such as grain, dust, or metal powders. Areas with potentially explosive atmospheres are often but not always posted.

Blasting Caps and Areas

To avoid possible interference with blasting operations, turn OFF your phone when you are near electrical blasting caps, in a blasting area, or in areas posted "Turn off electronic devices." Obey all signs and instructions.

Damaged Products





If your phone or battery has been submerged in water, punctured, or subjected to a severe fall, do not use it until you take it to a Motorola Authorised Service Centre to determine if it has been damaged. Do not attempt to dry it with an external heat source, such as a microwave oven.

Batteries and Chargers

Batteries can cause property damage and/or bodily injury such as burns if a conductive material such as jewellery, keys, or beaded chains touch exposed terminals. The conductive material may complete an electrical circuit (short circuit) and become hot. Take care when handling a charged battery, particularly when placing it inside a pocket, purse, or other container with metal objects. **Use only Motorola Original™ batteries and chargers.**

Caution: To avoid risk of personal injury, do not dispose of your battery in a fire.

Your battery, charger, or phone may contain symbols, defined as follows:

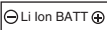
Symbol	Definition
	Important safety information will follow.
	Your battery or phone should not be disposed of in a fire.
	Your battery or phone may require recycling in accordance with local laws. Contact your local regulatory authorities for more information.
	Your battery or phone should not be thrown in the trash.
	Your phone contains an internal lithium ion battery.

Choking Hazards

Your phone or its accessories may include detachable parts, which may present a choking hazard to small children. Keep your phone and its accessories away from small children.

Glass parts

Some parts of your mobile device may be made of glass. This glass could break if the product is dropped on a hard surface or receives a substantial impact. If glass breaks, do not touch or attempt to remove. Stop using your mobile device until the glass is replaced by a qualified service centre.

Seizures/Blackouts

Some people may be susceptible to epileptic seizures or blackouts when exposed to flashing lights, such as when watching television or playing video games. These seizures or blackouts may occur even if a person never had a previous seizure or blackout.

If you have experienced seizures or blackouts, or if you have a family history of such occurrences, please consult with your doctor before playing video games on your phone or enabling a flashing-lights feature on your phone. (The flashing-light feature is not available on all products.)

Parents should monitor their children's use of video game or other features that incorporate flashing lights on the phones. All persons should discontinue use and consult a doctor if any of the following symptoms occur: convulsion, eye or muscle twitching, loss of awareness, involuntary movements, or disorientation.

To limit the likelihood of such symptoms, please take the following safety precautions:

- Do not play or use a flashing-lights feature if you are tired or need sleep.
- Take a minimum of a 15-minute break hourly.
- Play in a room in which all lights are on.
- Play at the farthest distance possible from the screen.

Repetitive Motion Injuries

When you repetitively perform actions such as pressing keys or entering finger-written characters, you may experience occasional discomfort in your hands, arms, shoulders, neck, or other parts of your body. Follow these instructions to avoid problems such as tendonitis, carpal tunnel syndrome, or other musculoskeletal disorders:

- Take a minimum 15-minute break every hour of game playing.
- If your hands, wrists, or arms become tired or sore while playing, stop and rest for several hours before playing again.
- If you continue to have sore hands, wrists, or arms during or after play, stop playing and see a doctor.

1. The information provided in this document supersedes the general safety information in user's guides published prior to January 28, 2005.

European Union Directives Conformance Statement



Hereby, Motorola declares that this product is in compliance with:

- The essential requirements and other relevant provisions of Directive 1999/5/EC
- All other relevant EU Directives

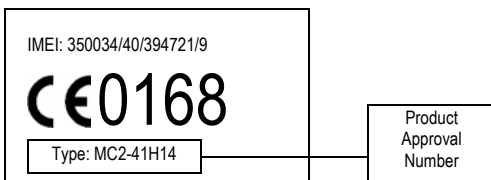

The above gives an example of a typical Product Approval Number.

You can view your product's Declaration of Conformity (DoC) to Directive 1999/5/EC (to R&TTE Directive) at www.motorola.com/rtte. To find your DoC, enter the product Approval Number from your product's label in the "Search" bar on the Web site.

Caring for the Environment by Recycling



When you see this symbol on a Motorola product, do not dispose the product with household waste.

Recycling Mobile Phones and Accessories



Do not dispose of mobile phones or electrical accessories, such as chargers or headsets, with your household waste. In some countries or regions, collection systems are set up to handle electrical and electronic waste items. Contact your regional authorities for more details. If collection systems aren't available, return unwanted mobile phones or electrical accessories to any Motorola Approved Service Centre in your region.

essentials

about this guide

This guide shows how to locate a menu feature as follows:

Find it: Press  > **Recent Calls** > **Dialed Calls**

This example shows that, from the home screen, you press  to open the menu, highlight and select  **Recent Calls**, then highlight and select **Dialed Calls**.

Press  to scroll to and highlight a menu feature. Press the **Select** key to select the highlighted menu feature.

symbols



This means a feature is network/subscription dependent and may not be available in all areas. Contact your service provider for more information.



This means a feature requires an optional accessory.

SIM card

Your *Subscriber Identity Module* (SIM) card contains personal information like your phone number and phonebook entries.

To insert and use a memory card, see page 29.

Caution: Don't bend or scratch your SIM card. Keep it away from static electricity, water, and dirt.

1

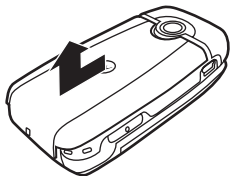

2

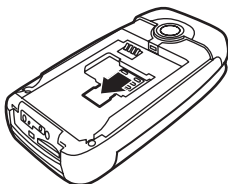

3

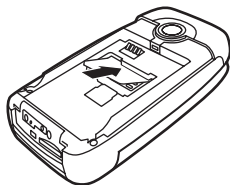

4

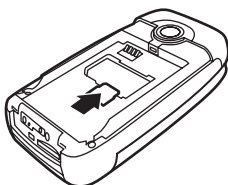

battery

battery installation

1

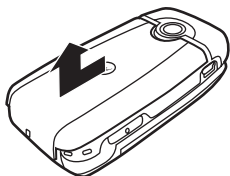

2

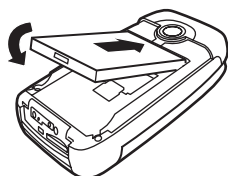

3

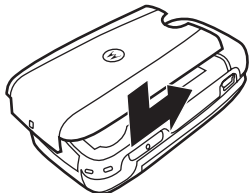

battery charging

New batteries are not fully charged. Plug the travel charger into your phone and an electrical outlet. Your phone displays **Charge Complete** when finished.

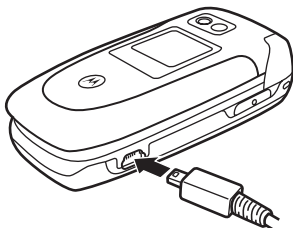

Tip: Relax, you can't overcharge your battery. It will perform best after you fully charge and discharge it a few times.

If your battery is completely drained, a PC USB charger will not charge it. Use the travel charger.

battery tips

Battery life depends on the network, signal strength, temperature, features, and accessories you use.

- Always use Motorola Original batteries and chargers. The warranty does not cover damage caused by non-Motorola batteries and/or chargers.
- New batteries or batteries stored for a long time may take more time to charge.
- When charging your battery, keep it near room temperature.
- When storing your battery, keep it uncharged in a cool, dark, dry place, such as a refrigerator.



- Never expose batteries to temperatures below -10°C (14°F) or above 45°C (113°F). Always take your phone with you when you leave your vehicle.
- It is normal for batteries to gradually wear down and require longer charging times. If you notice a change in your battery life, it is probably time to purchase a new battery.



Contact your local recycling center for proper battery disposal.

Warning: Never dispose of batteries in a fire because they may explode.

Before using your phone, read the battery safety information in the “Safety and General Information” section included in this guide.

turn it on & off

To turn on your phone, press and hold  for a few seconds or until the display turns on. If prompted, enter your 6-digit SIM card PIN code and/or 4-digit unlock code.



Caution: If you enter an incorrect PIN code 3 times in a row, your SIM card is disabled and your phone displays **SIM Blocked**. Contact your service provider.

To turn off your phone, press and hold  for 2 seconds.

make a call

Enter a phone number and press  to make a call.

To “hang up”, close the flip or press .



answer a call

Note: Your phone cannot receive data over an EDGE network while it is playing videos or some sound files. The EDGE  status indicator appears at the top of your display when you can receive data over an EDGE network.

When your phone rings and/or vibrates, just open the flip or press  to answer.

To “hang up,” close the flip or press .

your phone number

From the home screen, press   to see your number.

Tip: Want to see your phone number while you’re on a call? Press  > **My Tel. Numbers**.

To store or edit your name and phone number on your SIM card, press the **Edit** key while displaying it. If you don’t know your phone number, contact your service provider.





main attractions

You can do much more with your phone than make and receive calls!

take & send a photo

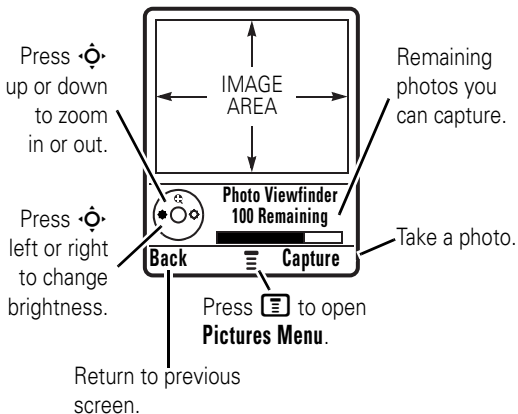
Press  to see the camera viewfinder:



- 1 Point the camera lens at the photo subject.
You can press  to open the **Pictures Menu**. See the table after this procedure.
- 2 Press the **Capture** key to take a photo.
 - To delete the photo and return to the active viewfinder, press the **Discard** key.
 - To store or send the photo, press the **Store** key.

When the viewfinder is active, press  to open the **Pictures Menu**:

option	
Go to Pictures	View stored pictures and photos.
Switch Storage Device	Choose to store and view pictures on your phone or memory card.  Note: High resolution photos can be stored only on your memory card.
Auto-Timed Capture	Set a timer for the camera to take a photo.
Pictures Setup	Open the setup menu to adjust photo settings.
View Free Space	See how much memory remains.

record video

Press  > **Multimedia** > **Video Camera** to see the video viewfinder.

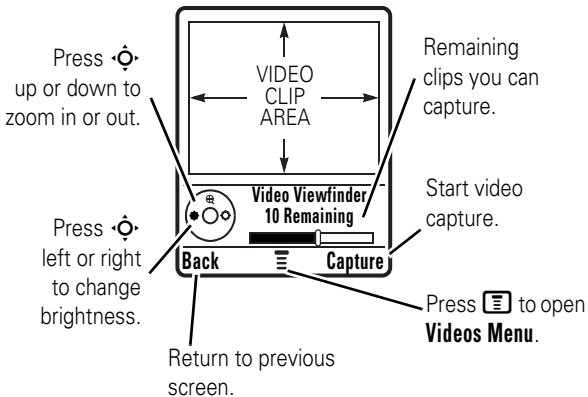

Note: You can zoom only before you start recording. The number of clips remaining is an estimate.

If you want to send your video in an MMS message, the video length must be set to MMS. To set length, press  > **Videos Setup** > **Video Length**.

Point the camera lens at the video subject, then:

- 1 Press the **Capture** key to start the video.
You can press the **Pause** key to pause video capture.
- 2 Press the **Stop** key to stop the video.

3 Press  > **Store Only** to store the video.

or

Press the **Send** key to send the video in a Multimedia Message.

or









Press the **Discard** key to delete the video and return to the active viewfinder.

MP3 audio player

You cannot use the audio player with a USB cable connected to your phone.

Your phone has an audio player in its **Games & Apps**:



Find it: Press  > **Games & Apps** > **Digital Audio Player**

Press  or right to highlight a button at the top of the audio player: play , pause , stop , previous , next , repeat , shuffle , and visualizer on/off 

Press  up or down to highlight an option:

options	
Playlists	Create or play a playlist of songs.
Artists	Select an artist to show or play their songs.
Albums	Select an album to show or play its songs.

options	
Songs	Show and play individual songs. Note: All of your phone's songs appear in the Songs list. Some songs do not have any Artists , Albums , or Genre information stored, so they don't appear in those lists.
Genres	Select a type of music to show or play songs.
Help	Show instructions on how to use the audio player
About	Show audio player version information

Tip: If you want music in a hurry, you can create a shortcut to the audio player. Highlight **Digital Audio Player** in the **Games & Apps** list, then press and hold . To use the shortcut from the home screen, press  and the shortcut key number.

To download songs to your phone, see page 80. To copy files between your phone and a computer, see page 28.

Note: Your phone cannot play MP3 files that have a bit rate higher than 192 kbps. If you try to download or play one of these files, your phone might show you an error or ask you to delete the file.

cable connections

 Your phone has a mini-USB port so you can connect it to a computer to transfer data.

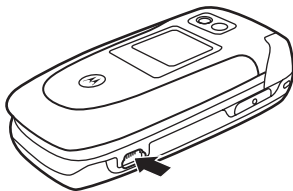

You can:

- Synchronize phonebook and datebook information between your phone and a computer or hand-held device.
- Use your phone as a modem to connect to the Internet.
- Use your phone to send and receive data calls from your computer or handheld device.

Note: Motorola Original USB data cables and supporting software are sold separately. Check your computer or hand-held device to determine the type of cable you need.



To **transfer data** between your phone and computer, you must install the software included with the Motorola Original data kit. See the data kit user's guide for more information. To make **data and fax calls** through a connected computer, see page 75.

memory card

You can use a removable memory card with your phone to store and retrieve multimedia objects (such as photos and sounds).



Note: If you download a copyrighted file and store it on your memory card, you can use the file only while your memory card is inserted in your phone. You cannot send, copy, or change copyrighted files.

install a memory card

- 1 Remove the battery door, if necessary.
- 2 Press the card in until it clicks into place.
- 3 Replace the battery door.

Do not remove your memory card while your phone is using it or writing files on it.

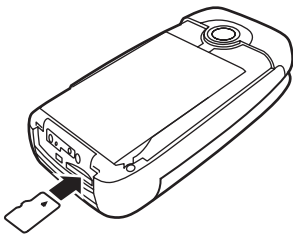

see and change memory card information

Find it: Press  > **Settings** > **Phone Status** > **Storage Devices**

- 1 Press  to highlight the memory card.
 - 2 Press the **Details** key to see the memory card information
- or**

Press  to see the **Storage Device** menu, which lets you **Format** or **Rename** the memory card.

To see memory card files, open a file list (such as **Pictures** or **Sounds**) and press  > **Switch Storage Device** > **Trans.**

To see files stored on your phone again, press

 > **Switch Storage Device** > **Phone.**

connect the memory card to a computer

You can access your phone's memory card with a PC.

Note: When your phone is connected to a computer, you can only access the memory card through the computer.

On your phone:

Press  > **Settings** > **Connection** > **USB Settings** > **Memory Card**.

This directs the USB connection to your memory card. Attach the Motorola Original USB cable to the accessory port on your phone and to an available USB port on your computer. Then follow these steps:



On your computer:

- 1 Open your “My Computer” window, where your phone’s memory card displays as a “Removable Disk” icon.
- 2 Click on the “Removable Disk” icon to access the files on your phone’s memory card.
- 3 To store the desired files onto the memory card, drag and drop them as follows: **MP3 files:** > mobile > audio
screen savers: > mobile > picture
wallpapers: > mobile > picture
video clips: > mobile > video
- 4 When you finish, remove the device by selecting the “Safely Remove Hardware” icon in the system tray at the bottom of your computer screen. Then select “USB Mass Storage Devices” and “Stop”.
- 5 Select “USB Mass Storage Device” then “Ok”.

On your phone:

To return to **Data Fax** as your USB default connection, press

 > **Settings** > **Connection** > **USB Settings** > **Data/Fax Connection**.

Bluetooth® wireless

Your phone supports Bluetooth wireless *pairing* (also called *linking* or *bonding*). You can pair your phone with a Bluetooth headset or car kit, or pair your phone with a computer to exchange and synchronize files.

Note: The use of wireless devices and their accessories may be prohibited or restricted in certain areas. Always obey the laws and regulations on the use of these products.

turn Bluetooth power on or off

Find it: Press  > **Bluetooth Link** > **Find Me** > **Power** > **On**

If Bluetooth **Power** is **On**, your phone can automatically pair with the handsfree device you have used before. Just turn on the device or move it near the phone.

Note: To extend battery life, use the above procedure and set Bluetooth **Power** to **Off** when not in use. Your phone will not pair with devices until you set Bluetooth **Power** back to **On** and pair your phone with the devices again.

pair with a headset or handsfree device

Before you try to pair your phone with a device, make sure your phone's Bluetooth power is **on** and the device is **on** and **ready** in *pairing* or *bonding* mode (see the user's guide for the device). You can pair your phone with only one device at a time.

Find it: Press  > **Bluetooth Link** > **Handsfree**
> **[Look For Devices]**



Your phone lists the devices it finds within range.

- 1 Highlight a device in the list and press the **Select** key.
- 2 Press the **Yes** or **Ok** key to pair with the device.
- 3 If necessary, enter the device passkey (such as 0000) and press the **Ok** key.

When your phone is paired, the Bluetooth indicator  displays in the home screen.

Tip: We can't see the device you're holding. For specific information about a device, refer to the instructions that came with it.













copy objects to another device

You can use Bluetooth pairing to copy a media object, phonebook entry, datebook event, or bookmark from your phone to a computer or other device.



- 1 Highlight the object on your phone that you want to copy to the other device.
- 2 Press  and select **Copy** (for media objects), **Send** (for datebook events), or **Share Phonebook Entry** (for phonebook entries).
- 3 Select a recognized device name, or **[Look For Devices]** to search for the device where you want to copy the object.

advanced Bluetooth features

feature		
make phone visible to other device	Allow a Bluetooth device to discover your phone:  > Bluetooth Link > Setup > Find Me	
pair with recognized device	Pair your phone with a recognized handsfree device:  > Bluetooth Link > Handsfree > <i>device name</i>	
drop pairing with device	Highlight the device name and press the Drop key.	
switch to device during call	Switch to a headset or car kit during a call:  > Use Bluetooth	
move multimedia object to device	Move a multimedia object to another device: Highlight the object, press  > Move , select the device name. Caution: Moving an object deletes the original object from your phone.	
edit device properties	Edit the properties of a recognized device: Highlight the device name, press the Edit key.	
set Bluetooth options	Highlight the device name, press  > Bluetooth Link > Setup	

basics



See page 1 for a basic phone diagram.

display

The *home screen* displays when you turn on the phone. To dial a number from the home screen, press number keys and .

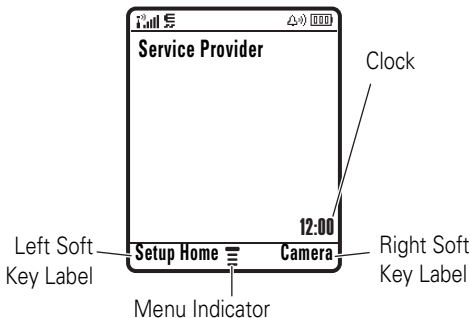
Note: Your home screen may look different from the one below, depending on your service provider.





The *Menu Indicator*  shows that you can press  to open the menu. *Soft Key Labels* show the current soft key functions. For soft key locations, see page 1.

Your home screen might display news from your service provider at the bottom. To change this news display, press  > **Settings** > **Personalize** > **Home Screen**.

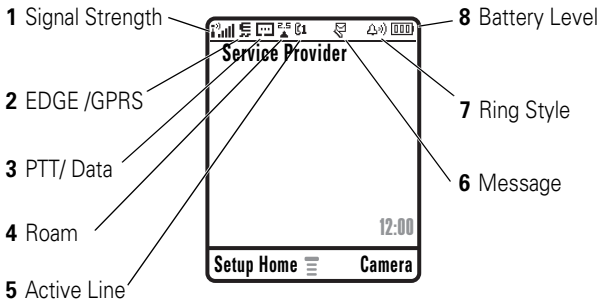

Status indicators can display at the top of the home screen:





1 Signal Strength Indicator – Vertical bars show the strength of the network connection. You can't make or receive calls when  or  displays.

2 EDGE/GPRS Indicator – Shows when your phone is using a high-speed *Enhanced Data for GSM Evolution* (EDGE) or *General Packet Radio Service* (GPRS) network connection. Indicators can include:

 = GPRS PDP context active

 = EDGE

 = GPRS packet data available

3 PTT / Data Indicator – Shows when you can make and receive PTT calls () or both PTT calls and Instant Messages (). Other indicators can include:

 = secure packet data transfer

 = unsecure packet data transfer

 = secure application connection

 = unsecure application connection

 = secure *Circuit Switch Data* (CSD) call

 = unsecure CSD call

 = Bluetooth® connection is active

- 4 Roam Indicator** – Shows when your phone is seeking or using a network outside your home network. Indicators can include:





 = 2G home

 = 2G roam

 = 2.5G home

 = 2.5G roam

- 5 Active Line Indicator** – Shows  to indicate an active call, or  to indicate when call forwarding is on. Indicators for dual-line-enabled SIM cards can include:



 = line 1 active

 = line 1 active, call forward on

 = line 2 active

 = line 2 active, call forward on

- 6 Message Indicator** – Shows when you receive a new message. Indicators can include:



 = text message

 = voice message

7 Ring Style Indicator – Shows the ring style setting.

🔔 = loud ring

🔔📶 = vibrate then ring

🔔📶 = soft ring

📶 = silent

📶 = vibrate







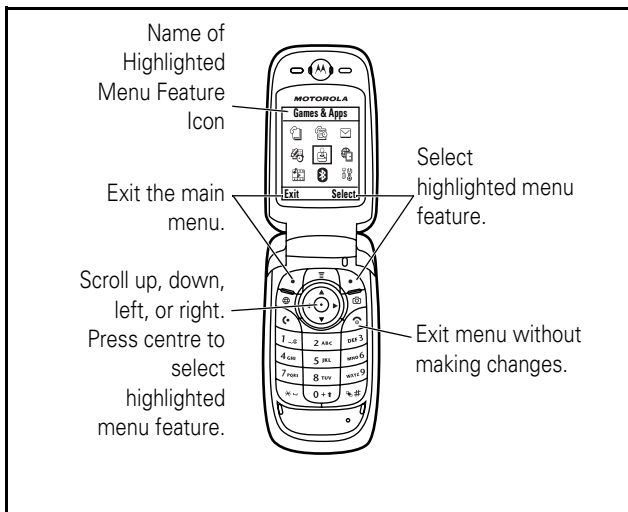



8 Battery Level Indicator – Vertical bars show the battery charge level. Recharge the battery when your phone shows **Low Battery**.

menus

From the home screen, press  to enter the main menu.



The following menu icons may be available, depending on your service provider and service subscription options.

menu features	
 Phonebook	 Multimedia
 Messages	 Bluetooth Link
 Recent Calls	 Settings
 Tools	 Camera
 Games & Apps	 Datebook
 Web Access	

Some features require you to select an option from a list:

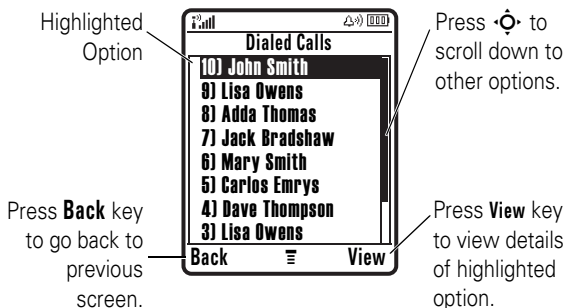

- Scroll up or down to highlight the option you want.
- In a numbered list, press a number key to highlight an option.
- In an alphabetized list, press a key repeatedly to cycle through its letters and highlight the closest matching list option.

- When an option has a list of possible settings, scroll left or right to select the setting.
- When an option has a list of possible numeric values, press a number key to set the value.

text entry



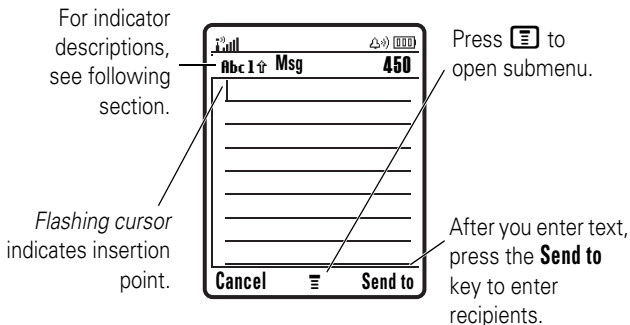

Some features let you enter text.







Press in a text entry screen to select an entry mode:

entry mode	
or 1	Your Primary text entry mode can be set to any iTAP® or tap 1 mode.
or 2	Your Secondary text entry mode can be set to any iTAP or tap 2 mode, or set to None if you don't want a secondary entry mode.
123	Numeric mode enters numbers only.
	Symbol mode enters symbols only.

To set your primary and secondary text entry modes, press  > **Entry Setup** in a text entry screen and select **Primary Setup** or **Secondary Setup**.

Tip: WANT TO SHOUT YOUR MESSAGE? Press  in a text entry screen to change text case to no capital letters (**abc**), next letter capital (**Abc** with , , **1↑**, or **2↑**), or all capitals (**ABC** with , , **1↑**, or **2↑**).

iTAP® mode

Press  in a text entry screen to switch to iTAP mode. If you don't see  or , press  > **Entry Setup** to set iTAP mode as your primary or secondary text entry mode.

iTAP mode lets you enter words using one keypress per letter. The iTAP software combines your keypresses into common words, and predicts each word as you enter it.

For example, if you press **7 7 6 4**, your phone displays:

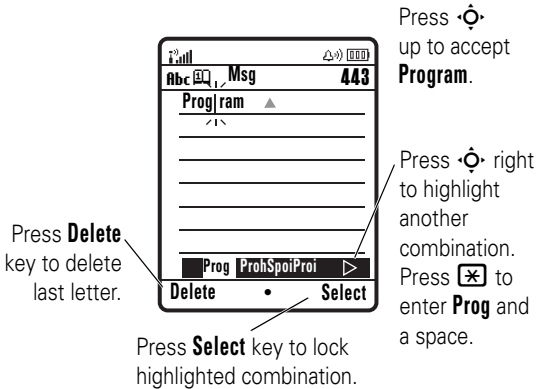

- If you want a different word (such as **Progress**), continue pressing keypad keys to enter the remaining letters.
- To enter numbers quickly, press and hold a number key to temporarily switch to numeric mode. Press the number keys to enter the numbers you want. Enter a space to change back to iTAP mode.
- Press **1** to enter punctuation or other characters.

tap mode

Press **#** in a text entry screen to switch to tap mode. If you don't see **Abc 1** or **Abc 2**, press **☰ > Entry Setup** to set tap mode as your primary or secondary text entry mode.

To enter text in tap mode, press a keypad key repeatedly to cycle through the letters and number on the key. Repeat this step to enter each letter.

For example, if you press **8** one time, your phone displays:

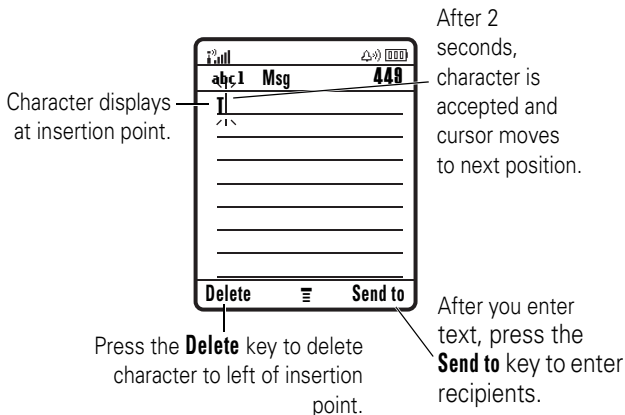

When you enter three or more characters in a row, your phone may guess the rest of the word. For example, if you enter **prog** your phone might display:

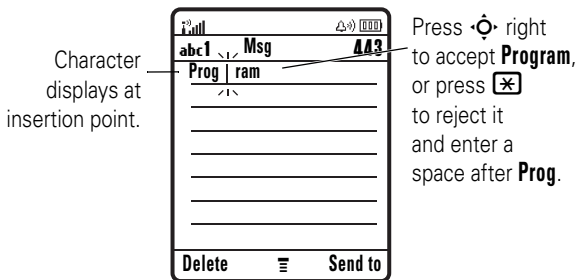

- The first character of every sentence is capitalized. If necessary, press **[down arrow]** to change the character to lowercase before the cursor moves to the next position.
- Press **[right arrow]** to move the flashing cursor to enter or edit message text.
- If you don't want to save your text or text edits, press **[cancel]** to exit without saving.
- *Tap extended* mode cycles through additional special characters and symbols as you repeatedly press a keypad key.

numeric mode

Press **[#]** in a text entry screen until you see **123**. Press the number keys to enter the numbers you want.

symbol mode

Press **#** in a text entry screen until you see **@**. Press a keypad key to show its symbols at the bottom of the display. Highlight the symbol you want, then press the **Select** key.

volume

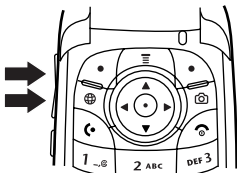

Press the volume keys to:

- turn off an incoming call alert
- change the earpiece volume during calls
- change the ringer volume from the home screen



Tip: Sometimes silence really is golden. That's why you can quickly set your ringer to **Vibrate** or **Silent** by holding the down volume key in the home screen.

navigation key

Press the *navigation key*  up, down, left, or right to scroll and highlight items in the display. When you highlight something, press the *center key*  to select it. The center key usually does the same thing as the right soft key.



external display

When your phone is closed, the external display shows the time, date, status indicators, and notifications for incoming calls and other events. For a list of phone status indicators, see page 34.

To set the phone ring style in the external display:

- 1 Press a volume key to display **Ring Styles**.
- 2 Press the smart key repeatedly, until the style you want appears.
- 3 Press a volume key to return to the home screen.

handsfree speaker

You can use your phone's handsfree speaker to make calls without holding the phone to your ear.

During a call, press the **Speaker** key to turn the handsfree speaker on. Your phone displays **Spkrphone On** until you turn it off or end the call.

Note: The handsfree speaker won't work when your phone is connected to a handsfree car kit or headset.

codes & passwords

Your phone's 4-digit **unlock code** is originally set to **1234**. The 6-digit **security code** is originally set to **000000**. If your service provider didn't change these codes, you should change them:

Find it: Press  > **Settings** > **Security** > **New Passwords**

You can also change your **SIM PIN** or call barring passwords.

If you forget your unlock code: At the **Enter Unlock Code** prompt, try entering 1234 or the last four digits of your phone number. If that doesn't work, press  and enter your 6-digit security code instead.

If you forget other codes: If you forget your security code, SIM PIN code, PIN2 code, or call barring password, contact your service provider.

lock & unlock phone

You can lock your phone to keep others from using it. To lock or unlock your phone, you need the 4-digit unlock code.

To **manually lock** your phone: Press  > **Settings** > **Security** > **Phone Lock** > **Lock Now**.

To **automatically lock** your phone whenever you turn it off: Press  > **Settings** > **Security** > **Phone Lock** > **Automatic Lock** > **On**.

Note: You can make emergency calls on a locked phone (see page 55). A locked phone still rings or vibrates for incoming calls or messages, **but you need to unlock it to answer**.

customize

ring style

Each ring style profile uses a different set of sounds or vibrations for incoming calls and other events. Here are the profiles you can choose:

 **Loud**

 **Vibrate**

 **Silent**

 **Soft**

 **Vibrate then Ring**

The ring style profile's indicator displays at the top of your home screen. To choose your profile:

Find it: Press  > **Settings** > **Ring Styles** > **Style:** *style name*

change alerts in a ring style

You can change the alerts for incoming calls and other events. Your changes are saved in the current ring style profile.

Find it: Press  > **Settings** > **Ring Styles** > *style Detail*

Note: *Style* represents the current ring style. You can't set an alert for the **Silent** ring style setting.

- 1 Highlight **Calls** (or **Line 1** or **Line 2** for dual-line phones), then press the **Change** key to change it.
- 2 Highlight the alert you want, then press the **Select** key.
- 3 Press the **Back** key to save the alert setting.



time & date

You need to set your phone's time and date to use the datebook.

To **synchronize** the time and date with the network: Press  > **Settings** > **Initial Setup** > **Time and Date** > **Autoupdate** > **On**.

To **manually** set the time and date, turn off **Autoupdate**, then: Press  > **Settings** > **Initial Setup** > **Time and Date** > *time* or *date*.

To choose an **analog or digital** clock for your home screen, press  > **Settings** > **Personalize** > **Home Screen** > **Clock**.

Note: If your home screen displays news information from your service provider, you must turn off the news display to see an analog clock. Press  > **Settings** > **Personalize** > **Home Screen** > **Home Style** > **Without News**. To choose an analog clock, press  > **Settings** > **Personalize** > **Home Screen** > **Setup without News** > **Clock** > **Analog**.

wallpaper

Set a photo, picture, or animation as a wallpaper (background) image in your home screen.

Find it: Press  > **Settings** > **Personalize** > **Wallpaper**

option	
Picture	Select an image for your wallpaper, or None for no wallpaper.

option	
Layout	Select Center to center the image in the display, Tile to repeat the image across the display, or Fit-to-screen to stretch the image across the display.

screen saver

Set a photo, picture, or animation as a screen saver. The screen saver displays when the flip is open and no activity is detected for a specified time.

Tip: This feature helps save your screen, but not your battery. To extend battery life, turn off the screen saver.

Find it: Press  > **Settings** > **Personalize** > **Screen Saver**

option	
Picture	Select an image for your screen saver, or None for no screen saver.
Delay	Select the length of inactivity before the screen saver displays.

display appearance

To choose a phone **skin** that sets the look and feel of your phone's display: Press  > **Settings** > **Personalize** > **Skin**.

To set your display **brightness**: Press  > **Settings** > **Initial Setup** > **Brightness**.

To save battery life, your **backlight** turns off when you're not using your phone. The backlight turns back on when you

open the flip or press any key. To set how long your phone waits before the backlight turns off:

Press  > **Settings** > **Initial Setup** > **Backlight**.

Note: To turn the backlight on or off for Java™ applications, press  > **Settings** > **Java Settings** > **App Backlight**.

To save battery life, the **display** can turn off when you're not using your phone. The display turns back on when you open the flip or press any key. To set how long your phone waits before the display turns off:

Press  > **Settings** > **Initial Setup** > **Display Timeout**.

answer options

You can use different ways to answer an incoming call. To turn on or turn off an answer option:

Find it: Press  > **Settings** > **In-Call Setup** > **Answer Options**

option	
Multi-Key	Answer by pressing any key.
Open to Answer	Answer by opening the flip.

calls

To make and answer calls, see page 22.

turn off a call alert



You can press the volume keys to turn off a call alert before answering the call.

recent calls

Your phone keeps lists of incoming and outgoing calls, even for calls that didn't connect. The most recent calls are listed first. The oldest calls are deleted as new calls are added.



Shortcut: Press  from the home screen to see the dialed calls list.



Find it: Press  > **Recent Calls**

- 1 Highlight **Received Calls** or **Dialed Calls**, then press the **Select** key.
- 2 Highlight a call. A ✓ next to a call means the call connected.
 - To call the number, press .
 - To see call details (like time and date), press the **View** key.
 - To see the **Last Calls Menu**, press . This menu can include:

option	
Store	Create a phonebook entry with the number in the No. field. Store does not appear if the number is already stored.
Delete	Delete the entry.
Delete All	Delete all entries in the list.
Hide ID/Show ID	Hide or show your caller ID for the next call.
Send Message	Open a new text message with the number in the To field.
Add Digits	Add digits after the number.
Attach Number	Attach a number from the phonebook or recent calls lists.
Send Tones	Send the number to the network as DTMF tones. This option displays only during a call.
Talk and Fax	Talk and then send a fax in the same call (see page 75). 

redial

- 1 Press  from the home screen to see the dialed calls list.
- 2 Highlight the entry you want to call, then press .

If you hear a **busy signal** and you see **Call Failed**, **Number Busy**, press  or the **Retry** key to redial the number. When the call goes through, your phone rings or 

vibrates one time, displays **Redial Successful**, and connects the call.

return a call

Your phone keeps a record of your unanswered calls, and displays **X Missed Calls**, where **X** is the number of missed calls.

- 1 Press the **View** key to see the received calls list.
- 2 Highlight the call you want to return, then press .

notepad

The last set of digits entered on the keypad are stored in *notepad* memory. This can be the last phone number you called, or a number that you “jot down” during a call for later use. To see the number stored in the notepad:

Find it: Press  > **Recent Calls** > **Notepad**

- To call the number, press .
- To create a phonebook entry with the number in the **No.** field, press the **Store** key.
- To open the **Dialing Menu** to attach a number or insert a special character, press .

hold or mute a call

Press  > **Hold** to put all active calls on hold.

Press **Mute** key (if available) or  > **Mute** to put all active calls on mute.

call waiting

When you're on a call, you'll hear an alert if you receive a second call.



Press  to answer the new call.

- To switch between calls, press the **Switch** key.
- To connect the two calls, press the **Link** key.
- To end the call on hold, press  > **End Call On Hold**.

To turn the call waiting feature on or off:

Find it: Press  > **Settings** > **In-Call Setup** > **Call Waiting**

caller ID

Calling line identification (caller ID) shows the phone number for an incoming call in your external and internal displays.



Your phone shows the caller's name and picture when they're stored in your phonebook, or **Incoming Call** when caller ID information isn't available.

You can set your phone to play a different ringer ID for an entry stored in your phonebook (see page 65).

To show or hide **your phone number** from the next person you call, enter the phone number and press  > **Hide ID/Show ID**.

emergency calls

Your service provider programs one or more emergency phone numbers, such as 911 or 112, that you can call under any circumstances, even when your phone is locked or the SIM card is not inserted.

Note: Emergency numbers vary by country. Your phone's preprogrammed emergency number(s) may not work in all locations, and sometimes an emergency call cannot be placed due to network, environmental, or interference issues.

- 1 Press the keypad keys to dial the emergency number.
- 2 Press  to call the emergency number.

international calls

If your phone service includes international dialing, press and hold  to insert your local international access code (indicated by +). Then, press the keypad keys to dial the country code and phone number.





1-touch dial

To call phonebook entries 1 through 9, press and hold the single-digit speed dial number for one second.

You can set 1-touch dial to call the entries in your phone's memory phonebook, your SIM card's phonebook, or your Fixed Dial list:

Find it: Press  > **Settings** > **Initial Setup** > **1-Touch Dial** > **Phone, SIM, or Fixed Dial**

To add a new phonebook entry, see page 64. To edit the **Speed No.** for a phonebook entry, press  > **Phonebook**, highlight the entry, and press  > **Edit**.

voicemail

Your network stores the voicemail messages you receive. To listen to your messages, call your voicemail number.



Note: Your service provider may include additional information about using this feature.

When you **receive** a voicemail message, your phone displays the voicemail message indicator  and **New Voicemail**. Press the **Call** key to listen to the message.

To **check** voicemail messages:

Find it: Press  > **Messages** > **Voicemail**

Your phone may prompt you to store your voicemail phone number. If you don't know your voicemail number, contact your service provider.

Note: You can't store a **p** (pause), **w** (wait), or **n** (number) character in this number. If you want to store a voicemail number with these characters, create a phonebook entry for it. Then, you can use the entry to call your voicemail.

push to talk (PTT) calls

Push to Talk (PTT) lets you talk walkie-talkie style with other PTT subscribers. You can talk to one person or a group.



PTT and the other related features indicated are network and subscription dependent features, and are not available in all areas. PTT connectivity requires PTT-compatible phones.



Note: To lock your PTT key or turn PTT on or off, see page 60.

make a PTT call

When  displays at the top of your home screen, you can make and receive PTT calls. To make a PTT call:

- 1 Enter a PTT subscriber's phone number in your home screen, or select a contact or group from a list:
 - **PTT Contacts** (press the PTT key to open the list)
Note: If you change your **Open To** setting, your PTT key does not open the contacts list (see page 61).
 - **PTT Quick Group** (press the PTT key and  > **PTT Quick Group**) This lets you select more than one contact for the call.
 - **PTT Groups** (press the PTT key and  > **PTT Groups**)
- 2 Hold the PTT key and speak after you hear the tone. Release the PTT key to let others speak.

To speak during a PTT call, hold your PTT key and speak after the tone. Only one person can speak at a time.

To end the call, press . If nobody speaks for 20 seconds, the call ends.

To send a PTT alert instead of a standard PTT call, highlight a PTT contact in **PTT Contacts** and press the **Alert** key. The contact's phone rings or vibrates, and the contact can speak first. If the contact does not respond, the call ends. You cannot send alerts to groups.

answer a PTT call

When you receive a PTT call, you hear a tone or alert followed by conversation from the caller.

- **To speak** when the caller stops speaking, hold your PTT key and speak after the tone. Only one person can speak at a time.
- **To end the call**, press .

If you change your **My Answer Mode** setting, your phone does not automatically answer as described (see page 61).



When you receive a PTT alert, press the PTT key and speak after the tone. You can also press the **Ignore** key to cancel the call.

Your phone displays **Missed Call** if you miss a PTT alert. It does not display **Missed Call** when you miss a standard PTT call unless you set **My Answer Mode** to **Manual** (see page 61).

PTT contacts and groups



You can store **PTT Contacts** to make one-to-one calls, or you can store **PTT Groups** to make group calls.

To store a contact, press **PTT key**  > **Add**. Enter the contact's **Name** and phone number (**No.**), then press the **Done** key. Your network stores the contact and your phone returns to the **PTT Contacts** list with the new contact displayed.

To create a group of contacts that you can call at the same time, press **PTT key**  > **PTT Groups**  > **Create New Group**. Enter the group's **Name** and select the **Members**, then press the **Done** key. Your network stores the group and your phone returns to the **PTT Groups** list with the new group displayed.

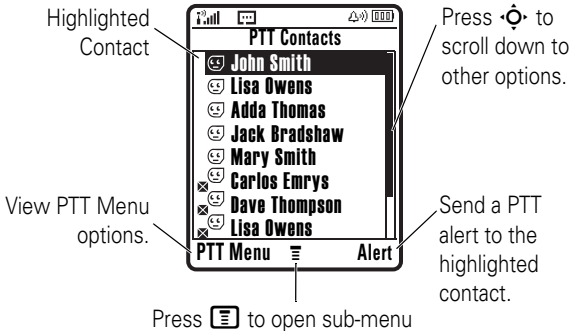
To view PTT contacts, press the PTT key. Scroll to a contact and press  to **View**, **Edit**, or **Delete** it.





To view PTT groups, press the PTT key and  > **PTT Groups**. Scroll to a group and press  to **View** or **Delete** it. You cannot

edit a group, but you can delete it and create a new one with the members you want.

Icons in the PTT contact and group lists indicate if someone is online (☺, ☺) or offline (☹, ☹). They also tell you if a contact is blocked (☹) (highlight the contact and press  > **Block** or **Unblock**).

To set an **online alert** (🔔) to tell you when a contact comes online, highlight the contact and press  > **Enable Online Alert**. You can turn online alert tones on or off in your **PTT Setup** menu (see page 61).

To refresh the contact or group list from your network, press  > **Refresh List**.

To view only your frequently used contacts or groups, press  > **Frequently Used**.

PTT settings

To **turn PTT on or off** from your home screen, press  > **Settings** > **PTT Settings** > **PTT Service** > **On/Off**.

To prevent accidental PTT calls, you can set your phone to **lock the PTT key** automatically when you haven't pressed it for a few minutes and your phone is closed. Press  > **Settings** > **Security** > **Lock PTT Key** and select how long your phone should wait before it locks the key. To unlock the key, hold it for 2 seconds or open the phone. The PTT key unlocks when you receive a PTT call.













You can change your PTT menu and call preferences.











Find it: Press **PTT key**  > **PTT Setup** > **PTT Personalize**

option	
Open To	From the home screen, the PTT key can open the PTT menu (Main Menu), or your contacts list sorted by name (Top of List), or most recent call (Last Call).
Sort by	Sort your contacts and groups by Name , online Status , or call Frequency .
My Answer Mode	Set the mode for incoming PTT calls to Manual (press the PTT key to answer), Auto-Accept (standard mode that accepts all calls), or Do Not Disturb (accepts no calls).
Tone Volume	Set the volume for the tone you hear when it is your turn to speak.
PTT Speaker	Turn the speakerphone On or Off for PTT calls.
Set Online Alert Tone	<p>You can set an online alert to tell you when a contact or group comes online (highlight the entry in your PTT Contacts or PTT Groups and press  > Enable Online Alert).</p> <p>This setting tells your phone whether to play these alert tones (On) or not (Off).</p>





other features







advanced calling









feature	
conference call	During a call: Dial next number, press  , press the Link key. 
transfer a call	During a call:  > Transfer , dial transfer number, press  
attach a phone number	Dial an area code or prefix for a phonebook number, then:  > Attach Number 
speed dial	Speed dial a phonebook entry: Enter speed dial number, press  , press  . To add a phonebook entry, see page 64. Tip: If you forget Aunt Mildred's speed dial number, press  > Phonebook , highlight her entry, and press the View key. 
call forwarding	Set up or cancel call forwarding:  > Settings > Call Forward 









feature	
restrict calls	Restrict outgoing or incoming calls:   > Settings > Security > Restrict Calls
call barring	Restrict outgoing or incoming calls:   > Settings > Security > Call Barring
change phone line	If you have a dual-line-enabled SIM card, you can change your line to make and receive calls from your other phone number.   > Settings > Phone Status > Active Line The active line indicator shows the active phone line (see page 36).
fixed dial	When you turn on fixed dialing, you can call only numbers stored in the fixed dial list.  Turn fixed dialing on or off:  > Settings > Security > Fixed Dial Use the fixed dial list:  > Tools > Dialing Services > Fixed Dial
DTMF tones	Activate DTMF tones:  > Settings > Initial Setup > DTMF To send DTMF tones during a call, just press number keys or highlight a number in the phonebook or recent calls lists and press  > Send Tones .

phonebook











feature	
add new entry	<p> > Phonebook  > New > Phone Number or Email Address</p> <p>Shortcut: Enter a phone number in the home screen, then press the Store key to create an entry for that number.</p> <p>Tip: One phone isn't enough for some people. When creating a phonebook entry, select More to store another number for the same Name.</p>
dial number	<p>Call a number stored in the phonebook:  > Phonebook, highlight the phonebook entry, press </p> <p>Shortcut: In the phonebook, press a keypad key one or more times to jump to entries that begin with the key's letters.</p>
record a voice name	<p>When creating a phonebook entry, highlight Voice Name and press the Record key. Press and release the voice key and say the entry's name (within 2 seconds). When prompted, press and release the voice key and repeat the name.</p> <p>Note: The Voice Name option isn't available in entries stored on the SIM card.</p>



















feature	
voice dial number	<p>Voice dial a number stored in the phonebook:</p> <p>Press and release the voice key, and say the entry's name (within 2 seconds).</p>
set ringer ID for entry	<p>Assign a ring alert (ringer ID) to an entry:</p> <p> > Phonebook > <i>entry</i></p> <p> > Edit > Ringer ID > <i>ringer name</i></p> <p>Note: The Ringer ID option isn't available in entries stored on the SIM card.</p> <p>Activate ringer IDs:</p> <p> > Settings > Ring Styles > <i>style Detail</i> > Ringer IDs</p>
set picture ID for entry	<p>Assign a photo or picture to display when you receive a call from an entry:</p> <p> > Phonebook > <i>entry</i>  > Edit > Picture > <i>picture name</i></p> <p>Note: The Picture option isn't available in entries stored on the SIM card.</p>
set picture ID view	<p>Display entries as a text list, or with picture caller ID photos:</p> <p> > Phonebook</p> <p> > Setup > View by > <i>view name</i></p>





feature	
set category for entry	<p> > Phonebook > <i>entry</i></p> <p> > Edit > Category > <i>category name</i></p> <p>Note: The Category option isn't available in entries stored on the SIM card.</p>
set category view	<p> > Phonebook</p> <p> > Categories > <i>category view</i></p> <p>You can display All entries, entries in a predefined category (Business, Personal, General, VIPs), or entries in a category you create.</p>
set primary number or address	<p>Set the primary number for an entry with multiple numbers:</p> <p> > Phonebook, highlight the entry, press</p> <p> > Set Primary > <i>number</i> or <i>address</i></p> <p>Tip: In Primary number view mode, you can still peek at other numbers stored for the same name. Highlight the name and press  left or right to see the other numbers.</p>
create group mailing list	<p> > Phonebook  > New > Mailing List</p>

feature	
sort phonebook list	Set the order in which entries are listed:  > Phonebook  > Setup > Sort by > <i>sort order</i> You can sort the phonebook list by Name , Speed No. , Voice Name , or Email . When sorting by name, you can display All numbers or just the Primary number for each name.
copy phonebook entry	Copy an entry from the phone to the SIM card, or from the SIM card to the phone:  > Phonebook , highlight the entry, press  > Copy > Entries > To
send phonebook entry in a text message	Send a phonebook entry in a text or email message:  > Phonebook , highlight the entry, press  > Send Contact
send phonebook entry over Bluetooth® connection	Send a phonebook entry to another phone, computer, or device:  > Phonebook , highlight the entry, press  > Share Phonebook Entry





messages







feature		
send text message	 > Messages > Create Message > New Text Message	
send multimedia message	 > Messages > Create Message > New Multimedia Msg	
send email	 > Messages > Create Message > New Email	
send voice message	 > Messages > Create Message > New Voice Msg	
use a multimedia template	Open a multimedia template with preloaded media:  > Messages > Create Message > MMS Template	
read new message	When your phone displays New Message , press the Read key to read the message you received.	







feature		
read old messages	 > Messages > Message Inbox	
	<p>Icons next to each message indicate if it is locked , has an attachment , or is urgent . Press  to perform various operations on a message.</p>	
read old email	 > Messages > Email Msgs	
	<p>Press  to perform various operations on a message.</p>	
store message objects	<p>Go to a multimedia message page, or highlight an object in a letter, then:</p>	
	 > Store	
store text messages on your SIM card	<p>To store incoming text messages on your SIM card, press:</p>	
	 > Messages >  > Message Setup > Text Msg Setup > Store To > SIM	
browser messages	<p>Read messages received by your micro-browser:</p>	
	 > Messages > Browser Msgs	
info services	<p>Read subscription-based information services messages:</p>	
	 > Messages > Info Services	

feature	
set up more email accounts	<p>You can set up, edit, and use more than one email account on your phone. Each account stores protocol, host, port, and other information. </p> <p> > Messages  > Email Msg Setup > Account Settings</p> <p>To edit it an account, select it. To set up a new account, select Create New.</p> <p>Note: Your phone displays a folder for each email account under  > Messages > Email Msgs.</p>

personalizing

feature	
language	<p>Set menu language:</p> <p> > Settings > Initial Setup > Language</p>
scroll	<p>Set the highlight bar to stop or wrap around in menu lists:</p> <p> > Settings > Initial Setup > Scroll</p>
activate ringer IDs	<p>Activate ringer IDs assigned to phonebook entries and categories:</p> <p> > Settings > Ring Styles > <i>style Detail</i> > Ringer IDs</p>
ring volume	<p> > Settings > Ring Styles > <i>style Detail</i> > Ring Volume</p>

feature	
keypad volume	 > Settings > Ring Styles > <i>style Detail</i> > Key Volume
reminders	Set reminder alerts for messages that you receive:  > Settings > Ring Styles > <i>style Detail</i> > Reminders
news display	If your service provider broadcasts news information that always appears in your home screen, you can turn the news display on or off:   > Settings > Personalize > Home Screen > Home Style > Without News or With News
menu view	Display the main menu as graphic icons or as a text-based list:  > Settings > Personalize > Main Menu > View
main menu	Reorder your phone's main menu:  > Settings > Personalize > Main Menu > Reorder

feature	
show/hide menu icons	<p>Show or hide menu feature icons in the home screen:</p> <p> > Settings > Personalize > Home Screen > Home Keys > Icons</p> <p>Note: In the Home Screen menu, select Setup with News or Setup without News if your service provider has a news display. </p>
change home keys	<p>Change the features for the soft keys and navigation key in the home screen:</p> <p> > Settings > Personalize > Home Screen > Home Keys</p> <p>Note: In the Home Screen menu, select Setup with News or Setup without News if your service provider has a news display. </p>
shortcuts	<p>Create a shortcut to a menu item:</p> <p>Highlight the menu item, then press and hold .</p> <p>Use a shortcut:</p> <p>Press , then press the shortcut number.</p>
master reset	<p>Reset all options except unlock code, security code, and lifetime timer:</p> <p> > Settings > Initial Setup > Master Reset</p>

feature

master clear

Clear all settings and entries you made **except** SIM card information, downloaded pictures and sound files, and reset all options **except** unlock code, security code, and lifetime timer:







 > **Settings** > **Initial Setup** > **Master Clear**

Caution: Master clear **erases all information you have entered** (including phonebook and datebook entries) **and content you have downloaded** (including photos and sounds) stored in your phone's memory. After you erase the information, you can't recover it.

call times & costs







Network connection time is the elapsed time from the moment you connect to your service provider's network to the moment you end the call by pressing . This time includes busy signals and ringing.



The amount of network connection time you track on your resettable timer may not equal the amount of time for which you are billed by your service provider. For billing information, contact your service provider.

feature		
call times	Display call timers:  > Recent Calls > Call Times	
in-call timer	Display time or cost information during a call:  > Settings > In-Call Setup > In-Call Timer	
call cost	Display call cost trackers:  > Recent Calls > Call Cost	

handsfree



Note: The use of wireless devices and their accessories may be prohibited or restricted in certain areas. Always obey the laws and regulations on the use of these products.

feature		
speakerphone	Activate a connected external speakerphone during a call: Press the Speaker key (if available, or  > Spkrphone On).	
auto answer (car kit or headset)	Automatically answer calls when connected to a car kit or headset:  > Settings > Car Settings or Headset > Auto Answer	
voice dial (headset)	Enable voice dial with headset send/end key:  > Settings > Headset > Voice Dial	

feature	
auto handsfree (car kit)	Automatically route calls to a car kit when connected:  > Settings > Car Settings > Auto Handsfree
power-off delay (car kit)	Set the phone to stay on for a specified time after the ignition is switched off:  > Settings > Car Settings > Power-Off Delay
charger time (car kit)	Charge the phone for a specified time after the ignition is switched off:  > Settings > Car Settings > Charger Time

data & fax calls

To connect your phone with a USB cable, see page 27.

feature	
send data or fax	Connect your phone to the device, then place the call through the device application.
receive data or fax	Connect your phone to the device, then answer the call through the device application.
talk then fax	Connect your phone to the device, enter fax number, press  > Talk and Fax , then press  to make the call.

feature

using sync

You can call an Internet server and synchronize your phonebook and datebook entries with the server.



To **set up** an Internet sync partner, press  > **Settings** > **Connection** > **Sync** > **[New Entry]**. Enter the server details, including **Server URL** (you can omit **http://**) and **Data Path** (the folder below the URL where your data is stored).

To **synchronize files** with a partner you set up, select the partner from the list in  > **Settings** > **Connection** > **Sync**.

network

feature











network settings





Display network information and adjust network settings:







 > **Settings** > **Network**

personal organizer

feature	
set alarm	 > Tools > Alarm Clock
turn off alarm	When an alarm displays: To turn off the alarm, press the Disable key or  . To set an 8 minute delay, press the Snooze key.
add new datebook event	 > Tools > Datebook , highlight the day, press  , press  > New
view datebook event	Display or edit event details:  > Tools > Datebook , highlight the day, press  , press the View key
event reminder	When an event reminder displays: To see reminder details, press the View key. To close the reminder, press the Exit key.
send datebook event to another device	Send a datebook event to another phone, computer, or device:  > Tools > Datebook , highlight the day, press  , highlight the event, press  > Send



feature	
create voice record	<p>Create a voice record:</p> <p>Press and hold the voice key, speak into the phone, release the voice key.</p> <p>Note: Recording phone calls is subject to varying state and federal laws regarding privacy and recording of conversations. Always obey the laws and regulations on the use of this feature.</p>
play voice record	<p>Play back a voice record:</p> <p> > Tools > Voice Records > <i>voice record</i></p>
calculator	<p> > Tools > Calculator</p>
currency converter	<p> > Tools > Calculator  > Exchange Rate</p> <p>Enter exchange rate, press the Ok key, enter amount, and press</p> <p> > Convert Currency.</p>











security

feature	
SIM PIN	Lock or unlock the SIM card:  > Settings > Security > SIM PIN Caution: If you enter an incorrect PIN code 3 times in a row, your SIM card is disabled and your phone displays SIM Blocked .
lock feature	 > Settings > Security > Lock Application
manage certificates	Enable or disable Internet access certificates stored on your phone:   > Settings > Security > Certificate Mgmt Certificates are used to verify the identity and security of Web sites when you download files or share information.

fun & games

For basic information on the camera, see page 23.

feature	
manage pictures	Manage photos, pictures, and animations:   > Multimedia > Pictures
manage video clips	 > Multimedia > Videos

feature		
manage sounds	Manage ring tones and music that you have downloaded or composed:	
		 > Multimedia > Sounds
create ring tones	Create ring tones that you can use with your phone:	
		 > Multimedia > Sounds > [New iMelody]
start micro-browser	Just press  .	
download objects from Web page	Download a picture, sound, or other object from a Web page: Press  , go to the page that links to the file, highlight the link, and select it. Note: Normal airtime and/or carrier usage charges apply.	
Web sessions	Select or create a Web session:	
		 > Web Access > Web Sessions
download game or application	You can download a Java™ game or application the same way you download pictures or other objects: Press  , go to the page that links to the file, highlight the link, and select it. Note: Normal airtime and/or carrier usage charges apply.	

feature

start game or application

Start a Java™ game or application:



 > **Games & Apps**, highlight the game or application, press the **Select** key

Note: To install and run games stored on your memory card, press 

> **Games & Apps** > **[Install New]**.

Specific Absorption Rate Data

This model meets international guidelines for exposure to radio waves.

Your mobile device is a radio transmitter and receiver. It is designed not to exceed the limits for exposure to radio waves recommended by international guidelines. These guidelines were developed by the independent scientific organization ICNIRP and include safety margins designed to assure the protection of all persons, regardless of age and health.

The guidelines use a unit of measurement known as the Specific Absorption Rate, or SAR. The ICNIRP SAR limit for mobile devices used by the general public is 2 W/kg and the highest SAR value for this device when tested at the ear was 0.72 W/kg.¹ As mobile devices offer a range of functions, they can be used in other positions, such as on the body as described in this user guide.² In this case, the highest tested SAR value is 0.64 W/kg.¹

As SAR is measured utilizing the device's highest transmitting power, the actual SAR of this device while operating is typically below that indicated above. This is due to automatic changes to the power level of the device to ensure it only uses the minimum level required to reach the network.

While there may be differences between the SAR levels of various phones and at various positions, they all meet the governmental requirements for safe exposure. Please note that improvements to this product model could cause differences in the SAR value for later products; in all cases, products are designed to be within the guidelines.

The World Health Organization has stated that present scientific information does not indicate the need for any special precautions for the use of mobile devices. They note that if you want to reduce your exposure

then you can do so by limiting the length of calls or using a “hands-free” device to keep the mobile phone away from the head and body.

Additional Information can be found on the websites of the World Health Organization (<http://www.who.int/emf>) or Motorola, Inc. (<http://www.motorola.com/rfhealth>).

1. The tests are carried out in accordance with international guidelines for testing. The limit incorporates a substantial margin for safety to give additional protection for the public and to account for any variations in measurements. Additional related information includes the Motorola testing protocol, assessment procedure, and measurement uncertainty range for this product.
2. Please see the *Safety and General Information* section about body worn operation.

index

A

- accessories 18, 74
- accessory connector port 1
- active line indicator 36
- active line, changing 63
- alarm clock 77
- alert
 - set 44, 47
 - turn off 44, 51
- animation 79
- answer a call 22, 50
- attach a number 62
- audio player 26

B

- backlight 49
- battery 19, 20
- battery indicator 37
- battery life, extending 20,
31, 49, 50
- Bluetooth connection 31,
33, 67, 77
- brightness 49
- browser messages 69
- browser. See micro-browser

C

- cables 27
- calculator 78
- call
 - answer 22, 50
 - end 22
 - make 22, 64
- call barring 46, 63
- call forward indicator 36
- call forwarding 62
- call timers 74
- call waiting 54
- caller ID 52, 54, 65
- camera 23
- car kit 74
- center key 1, 44
- certificate management 79
- clock 48
- codes 45, 46
- conference call 62
- copy files 32
- costs, tracking 74

D

data call 75
data indicator 35
date, setting 48
datebook 77
dial a phone number 22, 63,
64
dialed calls 51
digital audio 26
display 34, 49, 71
download media objects 69,
80
DTMF tones 63

E

earpiece volume 44
EDGE indicator 35
email 68, 69, 70
email address 64
emergency number 55
end a call 22
end key 1, 22
Enter Unlock Code message
46
external display 45

F

fax call 75
fixed dial 63
flip 22, 50
forward calls 62

G

games 80
GPRS indicator 35
group mailing list 66

H

handsfree speaker 45
headset 74
headset jack 1
hold a call 53
home screen 34, 71, 72

I

in-call indicator 36
Incoming Call message 54
information services 69
international access code
55
iTAP text entry mode 40

J

Java applications 80

K

keypad 50, 71

L

- language 70
- linking. See Bluetooth connection
- lock
 - application 79
 - phone 46
 - SIM card 79
- Low Battery message 37

M

- make a call 22, 64
- master clear 73
- master reset 72
- memory card 28
- menu 37, 70, 71
- menu icons 38, 71, 72
- menu indicator 34
- menu key 1, 18
- message 68, 69
- message indicator 36
- message reminders 71
- micro-browser 69, 80
- Missed Calls message 53
- MP3 sound files 26, 27
- multimedia message 68, 69
- music 80
- mute a call 53

N

- navigation key 1, 18, 44
- network settings 76
- news 34, 71
- notepad 53
- number. See phone number
- numeric entry mode 43

O

- object exchange 32
- 1-touch dial 55
- open to answer 50
- optional accessory 18
- optional feature 18

P

- pairing. See Bluetooth connection
- passwords. See codes
- personalize 70
- phone number 22, 63, 64
- phonebook 55, 62, 64
- photo 23, 79
- picture 79
- picture ID 54, 65
- PIN code 21, 46, 79
- PIN2 code 46
- power key 1, 21

PTT 57
calls, answering 58
calls, making 57
contacts and groups 59
icons 60
indicator 35
locking key 60
Quick Groups 57
settings 60
turning on or off 60
Push to Talk. See PTT

R

received calls 51
recent calls 51
redial 52
reminders 71
restrict calls 63
return a call 53
ring style indicator 37
ring style, setting 44, 47
ring tone 80
ringer ID 54, 65, 70
ringer volume 44, 70
roam indicator 36

S

screen saver 49
security code 45
send key 1, 22
shortcuts 72

signal strength indicator 35
SIM 69
SIM Blocked message 21,
79
SIM card 18, 21, 46, 79
skin 49
smart key 45
soft keys 1, 34, 72
speakerphone 74
speed dial 62
store your number 22
symbol entry mode 44
synchronizing 76

T

tap text entry mode 41
telephone number. See
phone number
text entry 39
text message 68, 69
time, setting 48
timers 74
transfer a call 62
turn on/off 21

U

unlock
 application 79
 phone 21, 46
 SIM card 79
unlock code 45, 46
USB cables 27

V

video clip 79
videos 25
voice dial 65, 74
voice message 68
voice name, recording 64
voice record 78
voicemail 56
voicemail message indicator
 36, 56
volume 44, 70, 71

W

wallpaper 48
Web pages 80
Web sessions 80
wireless connection. See
 Bluetooth connection

Y

your phone number 22