

efergy

Wireless Energy Meter
Art.no.: 36-4000
Model: Efergy elite 2.0

TABLE OF CONTENTS

INTRODUCTION	3
SAFETY	4
PACKAGE CONTENTS	5
FINDING THE POWER SUPPLY CABLE FOR YOUR ELECTRICITY METER (UK)	6
FINDING THE POWER SUPPLY CABLE FOR YOUR ELECTRICITY METER (SE) (NO) (FIN)	8
INSTALLATION	10
SYNCHRONISING THE TRANSMITTER AND DISPLAY UNIT	11
SETTING THE TIME AND DATE	12
OTHER SETTINGS	13
DUAL TARIFF	15
DISPLAY INFORMATION	17
NORMAL DISPLAY OF PRESENT CONSUMPTION	18
PREVIOUS CONSUMPTION DISPLAY	19
TROUBLESHOOTING	20
DISPOSAL	22
SPECIFICATIONS	22

INTRODUCTION

The measuring and monitoring of energy is the basis for saving energy. You need this information in order to know where and how you can save money.

Efergy is an energy meter which shows how much energy is consumed in your home at the time you read the display. The display can also give the user information on consumed energy costs. You can also move the receiver around the house and turn on or off an electrical device to see the difference in power consumption directly on the display.

If you have any questions regarding technical problems please contact Customer Services.

SAFETY

IT IS VERY IMPORTANT THAT YOU TAKE INTO CONSIDERATION A FEW SIMPLE PRECAUTIONARY MEASURES BEFORE USING THIS PRODUCT

Efergy energy meters are easy to install. Still, there are some essential safety rules that you must be conscious of:

- In the UK or Ireland the installation of the energy meter is easy, since the only thing that is required is to connect a sensor to the incoming mains power cable. If you still feel unsure as to how to mount the sensor, we recommend that you contact a qualified electrician.
- In the Scandinavian countries a 3-phase system is used, which means that one must install all three included sensors. The sensor clamps should be clamped over the incoming electrical cables in or outside the distribution box. Contact a qualified electrician if you are unsure as to how to install the sensors.
- Read and follow the important information contained in the following pages. Remember that the energy meter's sensors do not need to have direct electrical contact at the measuring point. The sensors should sit around the cable.
- If you find something unusual in or around the distribution box like loose cables, bare cables, burn marks, openings in the insulation jacket or any other damage, etc. you must immediately quit working and contact your electric company or the person responsible for electrical installations.
- The cables must not be bent or overloaded when mounting the sensors.

If you are uneasy or have any questions regarding the mounting of the energy meter's sensors, contact a qualified electrician immediately.

The sensors do not need to be removed during the lifetime of the equipment. However, batteries need to be changed occasionally in the transmitter and display unit. The sensors do not have any batteries that need to be changed.

efergy

PACKAGE CONTENTS

- 3 x Sensors (current transformer)
- 1 x Transmitter
- 1 x Display unit (receiver)

You should clamp the sensors over the incoming mains power cables leading into the distribution box. All power consumed in the household enter through these cables.

The clip-on sensor senses the current which passes through these cables. A reading of the amount of passing current is then wirelessly sent to the display unit via the transmitter. The energy consumption is shown directly on the display.

Sensor

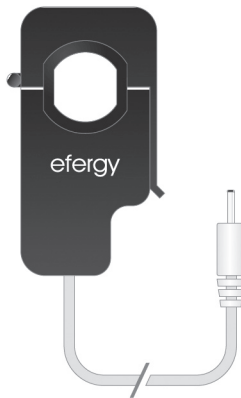

Transmitter



Display unit

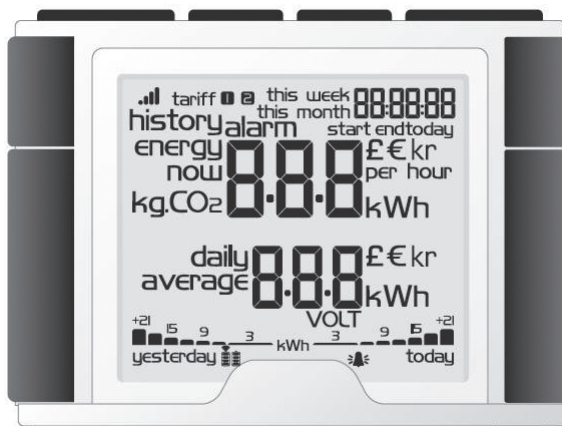

FINDING THE POWER SUPPLY CABLE FOR YOUR ELECTRICITY METER (UK)

The Efergy energy meter is installed by clamping the sensor clips around the incoming mains power cables leading to your electricity meter.

FINDING YOUR ELECTRICITY METER

Find out about your electricity meter and check which type you have. It is normally found on an outer wall, in the garage, in the cellar or in a utility room. If you live in a flat, it may be located near the entry door, in the stairway, or in the cellar. Make sure the cables exiting the bottom of the electricity meter are accessible.

Modern offices and flats can have safety panels which protect the cables entering the electricity meter. If this is your situation, we recommend that you contact a qualified electrician.

FINDING THE POWER SUPPLY CABLE

There are four cables at the bottom of the electricity meter. The cable on the right (cable 4) is always the live feed wire (Active phase) from the meter to the fuse box (see diagram 1).

Certain installations have cables 1 and 2 entirely or partially covered in order to hinder modification or home installation of cables before the meter (see diagram 2). Connect the sensor to cable 4 (on the far right) Meters with dual tariffs (see diagram 3) often have an extra cable between cable 3 and 4. The extra cable has a smaller diameter than the other cables and leads to another electricity meter close by.

Diagram 1

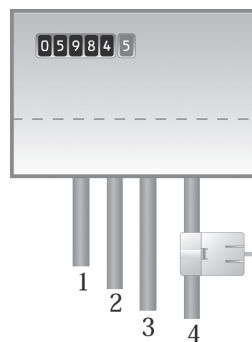
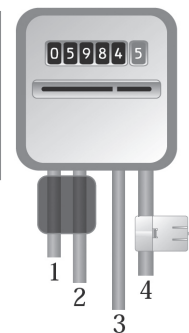

Diagram 2



Newer installations normally have two cables on the underside of the meter. One of the cables is the earth cable and the other is the feed cable. The sensor should be clamped around the feed cable (normally coloured brown).

If you have a 3-phase supply or if you have an Economy 7 meter you will need additional sensors. The extra sensors easily connect to the socket at the base of the transmitter.

N.B. The energy meter comes with 3 sensors.

Diagram 3

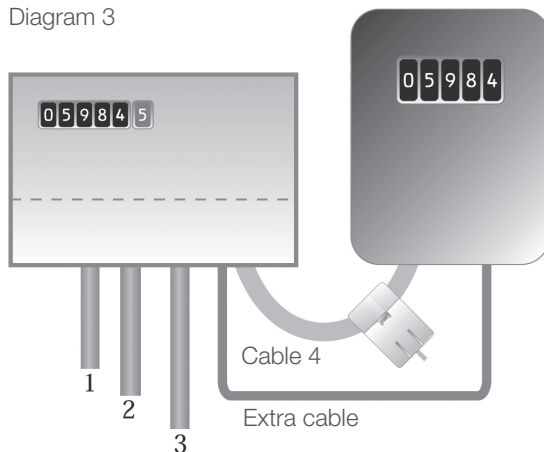

SAFETY

You should under no circumstances connect a sensor to a cable if any of the cables leading to the meter is damaged in any way. No cables need to be cut. Do not clip any cables. Do not break any seals or such on the meter.

Contact your local electricity supplier if you are at all uncertain about connecting the sensor to the correct cable.

FINDING THE POWER SUPPLY CABLE FOR YOUR ELECTRICITY METER (SE) (NO) (FIN)

The Efergy energy meter is installed by clamping the sensor clips around the incoming mains power cables leading to your electricity meter.

FINDING YOUR ELECTRICITY METER/DISTRIBUTION BOX

Find out where your meter is located. It is normally found on an outer wall, in the garage, in the cellar or in a utility room. If you live in a flat, it may be located near the entry door, in the stairway, or in the cellar. Make sure the cables exiting the bottom of the electricity meter are accessible.

Modern homes and flats can have safety panels which protect the cables entering the meter. These are often sealed. Under no circumstances should the seals be broken other than by a qualified electrician. Instead, we recommend that the sensors be installed after the main switch in your distribution box.

If you still feel unsure as to how to mount the sensor, we recommend that you contact a qualified electrician.

efergy

FINDING THE POWER SUPPLY CABLE

In Sweden, Norway and Finland there are four feed cables entering the electricity meter: 3 live phases (L1, L2, L3) and 1 Neutral (N), Neutral is normally blue and the live cables are either black or brown. Cables L1 – L2 – L3 are live and it is these that the sensors should be attached to.

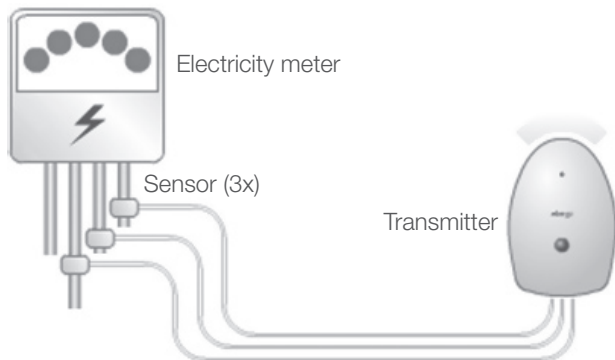

SAFETY

You should under no circumstances connect a sensor to a cable if any of the cables leading to the meter is damaged in any way. No cables need to be cut. Do not clip any cables. Do not break any seals or such on the meter.

Contact your local electrical supplier if you are at all uncertain about connecting the sensors to the correct cable.

INSTALLATION

MOUNTING THE SENSORS

The sensors should be clamped onto one (UK) or three (SE) (NO) (FIN) live feed phases. The sensors can be used on cables up to 12 mm in diameter. The sensor must not be mounted with force.

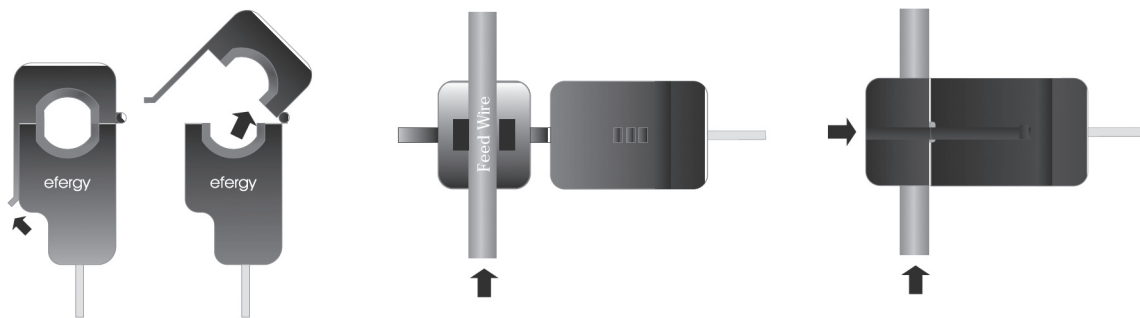

1. Find your live feed cable (UK), cables (SE) (NO) (FIN).
2. Press the release cap upwards to open the sensor.
3. Make sure that you have the correct cable and place the sensor around the cable.
4. Press the sensor together and a click will be heard when the release cap locks.
5. Mount a sensor on the respective live feed cables L1, L2, L3 (SE) (NO) (FIN).

CONNECT THE SENSOR TO THE TRANSMITTER

Plug the sensors into the sockets on the bottom of the transmitter. The sensors/plugs do not have to be in any particular order.



The sensor senses the current which passes through these cables. A reading of the amount of passing current is wirelessly sent to the display unit via the transmitter. The energy consumption is shown directly on the display.

efergy

SYNCHRONISING THE TRANSMITTER AND DISPLAY UNIT

1. Start by inserting three AA/LR6 batteries into the transmitter's battery compartment, and three AA/LR6 batteries in the display unit's battery compartment.

Tip: If the transmitter is located outdoors, it is extra important to use good quality batteries. Use Alkaline or preferably Lithium batteries which tolerate cold better.

2. Press [Link] on the backside of the display unit. The transmitter icon  will flash for a minute.
3. Press the button on the front of the transmitter once while the transmitter icon  flashes. Wait until the icon stops flashing.

Tip: If synchronisation is successful, the transmission icon  will show on the display.

— — — will show on the display if unsuccessful.

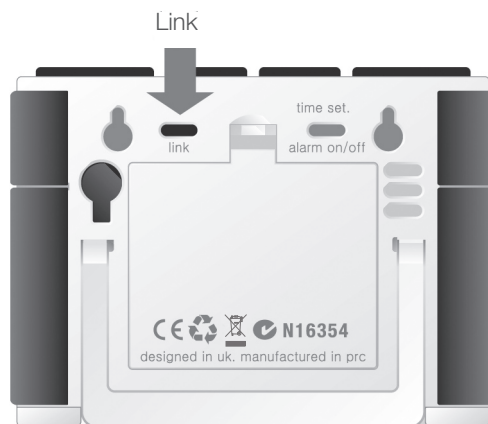

N.B. The preinstalled update interval is six seconds. This means that the transmitter sends updates every six seconds. It is possible to adjust this interval to 6, 12 or 18 seconds by depressing the transmission button for two seconds (The LED colour will change).

- Red = 6 s.
- Orange = 12 s.
- Green = 18 s.

SETTING THE TIME AND DATE

The energy meter must be programmed with the correct time and date in order to give accurate information. Setting the time and date:

STEP 1

On the back of the display there is a settings button [Time set]. Depress this button for two seconds. The date display will begin to flash.

STEP 2

Set the correct date using the [Bwd] and [Fwd] buttons. Press [Mode] to confirm and to continue on to setting the month. Repeat this procedure to set the year. Press [Mode] to confirm and to continue with setting the time.

STEP 3

Set the correct hour using the [Bwd] and [Fwd] buttons. Press [Mode] to confirm and to continue. Repeat this procedure to set the minutes. Press [History] to confirm the setting.

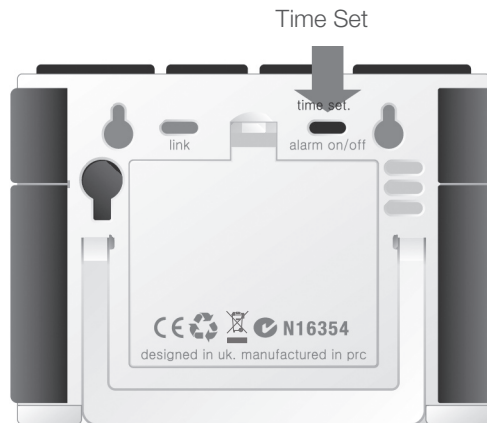

OTHER SETTINGS

The energy meter must be programmed with the correct tariff per kWh in order to give accurate information. Setting the tariff (valid only if you DO NOT have a dual tariff meter).

N.B. You must be in normal display mode before adjusting any settings. Press [History] the required number of times until history NO LONGER shows in the display.

Activating the settings mode: Depress [Mode] for two seconds.

N.B. If no button is pushed for 20 seconds the display will go back to normal display mode without saving any changes.

STEP 1. VOLTAGE

Depress [Mode] for two seconds. 230 will flash (230 V is preset). Adjust the voltage using [Bwd] and [Fwd] if you have a different mains voltage. Press [Mode] to confirm and to continue to the currency setting.

STEP 2. CURRENCY

Set the correct currency (£, €, or kr) using the [Bwd] and [Fwd] buttons. Press [Mode] to confirm and to continue to the tariff setting.



STEP 3. SINGLE TARIFF

The **tariff**  symbol will begin flashing. Press [Mode] to confirm if you use a single tariff. Refer to section *Dual Tariff* if you have an electricity meter for dual tariffs.

Tip: During the entire installation process you may press [History] to save your settings and return to normal display mode.

STEP 4. COSTS

Set the correct tariff using the [Bwd] and [Fwd] buttons. Press [Mode] to confirm and continue.

STEP 5. KG CO₂ (KG CARBON DIOXIDE PER KWH)

The kg CO₂/kWh can be adjusted with the [Bwd] and [Fwd] buttons. Press [Mode] to confirm and continue on to setting the alarm.

STEP 6. ALARM (HIGH-ENERGY CONSUMPTION ALARM)

The preset alarm value is set to 5 kW. If the alarm feature is activated and you use more than 5 kW the alarm will sound and a red indicator lamp will light on the display unit. The alarm activation value can be set using the [Bwd] and [Fwd] buttons. Press [Mode] to confirm. Press [Alarm on/off] on the back of the display unit to activate or deactivate the alarm. Press [History] to exit the settings mode.

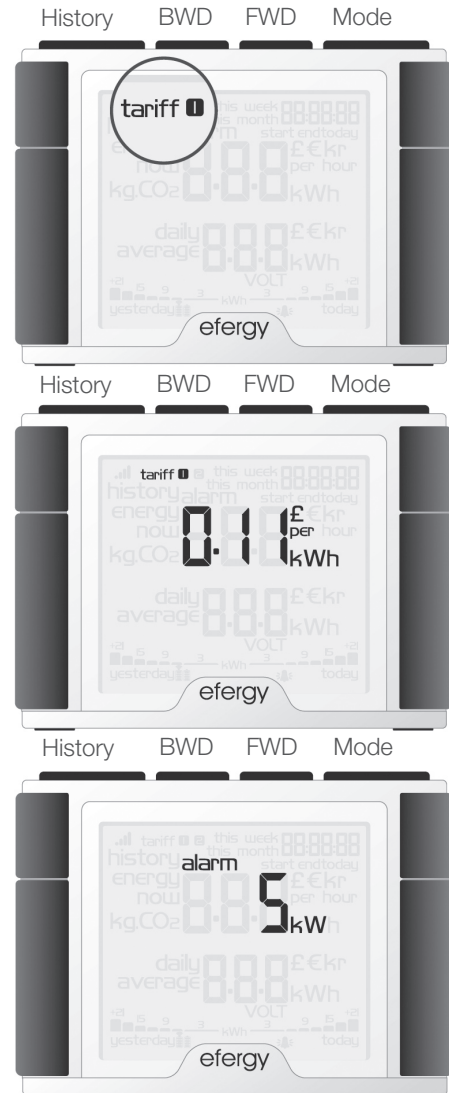

efergy

DUAL TARIFF

If you have an electric meter with dual tariffs, you need to program the energy meter for this function.

STEP 1. ACTIVATING DUAL TARIFFS

Depress [Mode] for two seconds. The value for the set voltage (230) will begin to flash. Press [Mode] two times to open the dual tariff settings mode. **tariff 0** will flash on the display. Advance to **tariff 1 2** with the [Bwd] or [Fwd] buttons. Press [Mode] to confirm. **start** and **tariff 0** will begin flashing.

STEP 2. SETTING THE START & STOP TIMES FOR TARIFF 1

Set the start time for tariff 1 with the [Bwd] or [Fwd] buttons. First set the start time by setting the hours and press [Mode] to confirm. Continue setting the minutes using the same process. Press [Mode] to confirm. **start** is replaced by **end** on the display. Set the stop time for tariff 1 using the same process.

Example: You are on an Economy-7 tariff from 01.00 to 08.00. Set the **start tariff 0 01.00** and the **end tariff 0 08.00**.

Press [Mode] to confirm. Then set the currency and tariff per kWh for both tariffs for both day and night.



STEP 3. SETTING TARIFF 1

The preset value will begin flashing. Set the present tariff per kWh with the [Bwd] or [Fwd] buttons. Press [Mode] to confirm.

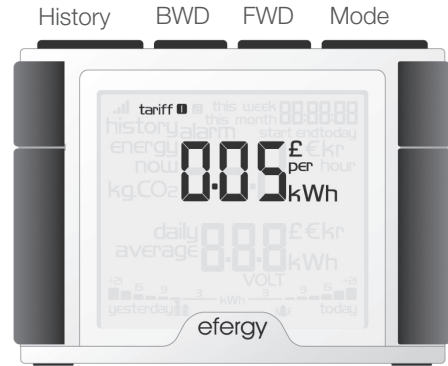

STEP 4. SETTING TARIFF 2

The preset value of **tariff 0.2** will begin flashing. Set the present tariff per kWh with the [Bwd] or [Fwd] buttons. Press [Mode] to confirm. 0.50 (kg CO₂/kWh) will begin flashing on the display.

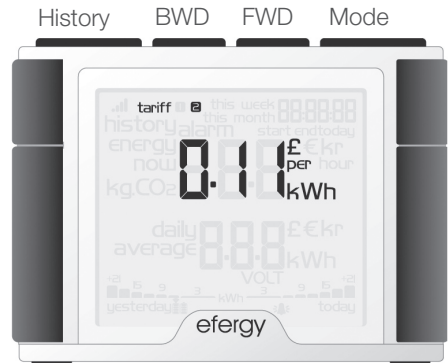

efergy

DISPLAY INFORMATION

The energy meter displays information on present, previous and average energy consumption.

PRESENT AVERAGE CONSUMPTION

The display shows average consumption in kWh, cost or carbon dioxide emissions*. Press [Mode] to switch between displaying kWh, tariff or kg CO₂.

* Amount of produced kg CO₂ used for the production of the electricity consumed.

The amount of CO₂ produced depends on how your electrical energy is produced e.g. hydro-electric-, wind-, coal-power, etc. It is up to you to determine and set the CO₂ per kWh value. (See *Other Settings*, Step 5)



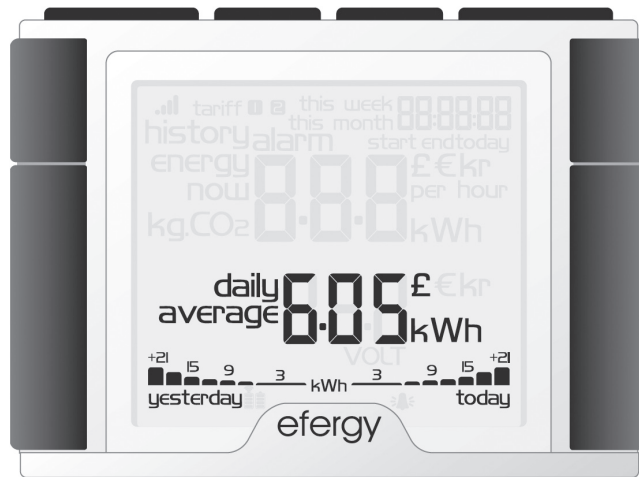

GRAPHIC DISPLAY

On the bottom portion of the display a graphic representation for the current day and the previous day's energy consumption is shown.



NORMAL DISPLAY OF PRESENT CONSUMPTION

The following is shown on the display:

1. Transmission strength icon 
2. Tariff per hour or present consumption (change settings with the [Mode] button)
3. Low battery warning:
Transmitter 
Display unit 
4. Alarm activated: 

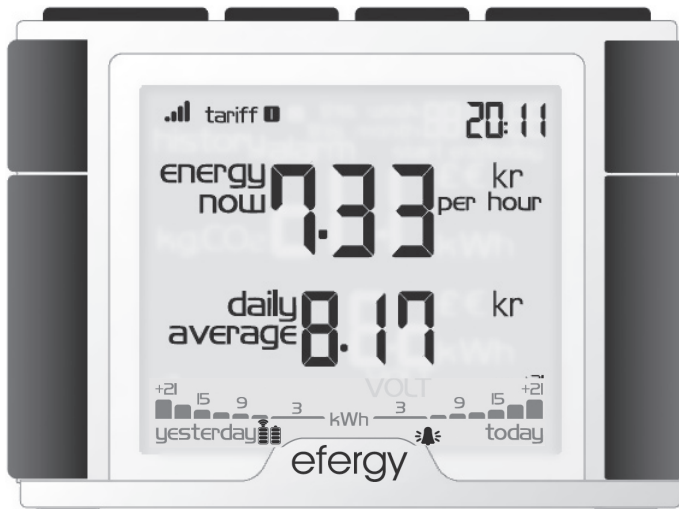

efergy

PREVIOUS CONSUMPTION DISPLAY

- Press [History] to display previous consumption.
- Press [History] to switch between displays. Current day's energy consumption – most recent week – most recent month.
- Switch between day/month with [Bwd] or [Fwd] to compare energy consumption.
- Press [Mode] to switch between displaying kWh- tariff - amount CO₂.

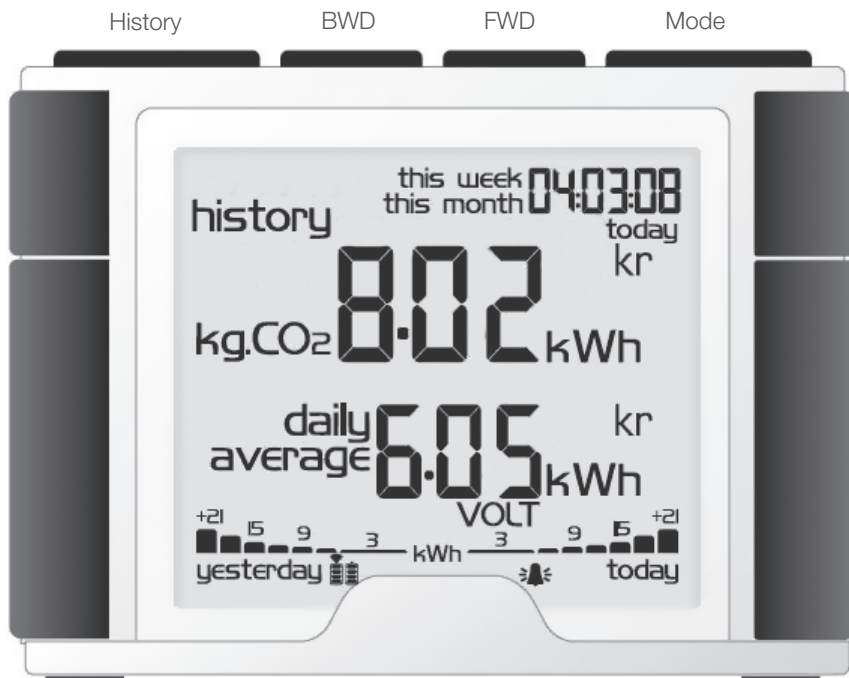

TROUBLESHOOTING/FAQ

If I remove the battery, will I lose all my saved data?

No, the information is saved in the internal memory and is not lost when the battery is changed.

How do I reset the display (erase all data and start over)?

Depress [History] and [Mode/set] simultaneously. Clr will show on the display.

N.B. If you reset the energy meter all information on previous consumption is erased.

However, time and date information is saved in the memory.

What is the transmitter's range?

The range is over 40 metres in a normal home. The 433 MHz frequency is very suitable for this purpose. With good conditions the signals are able to span up to three floors.

The display shows — — —. What does it mean?

Move the display unit closer to the transmitter and press [Link]. If the problem persists, contact our Customer Services.

Why does the background light come on sometimes?

The background light is timer controlled in order to save the battery. It is only activated at night.

The transmitter and the display unit (receiver) don't seem to have contact with each other. What do I do?

Move the display unit closer to the transmitter and press [Link]. If this doesn't help, try changing the transmitter batteries. If the problem persists contact our Customer Services.

What does the graph stand for?

The graph on the bottom portion of the meter's display represents kWh. The measured range of the graph is from 3 kWh to 21 kWh. This means that the bar graph will not display any average consumption readings below 3 kWh. This also means that the bars on the graph will all be full if the average daily reading is over 21 kWh.

What is the energy meter's display capacity?

It can measure up to 999 kWh in a week

Settings specific to Norwegian electrical networks (IT-nett, TN-nett)

IT-net: The value should be set to 130 V, (IT nett has 230 V between phases).

TN-net: The value should be set to 230 V, (TN-net has 400 V between phases).

How thick can the cables be that the sensors clamp onto?

The sensors can be used on cables up to 12 mm in diameter.

What should the measurement voltage be set to in each respective country?

In Sweden, Finland and the UK the measurement voltage should be set to 230 V.

In Norway the measurement voltage should be set to: 130 V (IT-net) or 230 V (TN-net).

DISPOSAL

Follow local ordinances when disposing of this product. If you are unsure of how to dispose of this product, please contact your municipality.



SPECIFICATIONS

Model:	Efergy elite 2.0
Frequency:	433 MHz
Transmission intervals:	6 – 12 – 18 seconds
Range:	70 metres
Measuring voltage:	110 – 400 V
Measuring current:	50 mA – 95 A
Accuracy:	> 90 %
Backlight:	Activated between 18:00 and 06:00
Power supply:	Adaptor 5 V, 100 mA (not included).

efergy

DECLARATION OF CONFORMITY



Hereby, Clas Ohlson AB, declares that following product(s):

**Wireless Power Meter
36-4000 Elite, WPM100**

is in compliance with the essential requirements and other relevant provisions
of Directive 1999/5/EC.

Article 3.1a (Safety): EN 60950-1

Article 3.1b (EMC): EN 55022
EN 55024
EN 301489-1
EN 301489-3

Article 3.2 (Radio): EN 300220-1
EN 300220-2



Insjön, Sweden, November 2009

A handwritten signature in black ink, appearing to read 'Klas Balkow', is written over a horizontal line.

Klas Balkow
President

Clas Ohlson, 793 85 Insjön, Sweden

SVERIGE

KUNDTJÄNST
INTERNET
BREV

Tel: 0247/445 00 Fax: 0247/445 09 E-post: kundtjanst@clasohlson.se
www.clasohlson.se
Clas Ohlson AB, 793 85 INSJÖN

NORGE

KUNDESENTER
INTERNETT
POST

Tlf.: 23 21 40 00 Faks: 23 21 40 80 E-post: kundesenter@clasohlson.no
www.clasohlson.no
Clas Ohlson AS, Postboks 485 Sentrum, 0105 OSLO

SUOMI

ASIAKASPALVELU
INTERNET
OSOITE

Puh.: 020 111 2222 Sähköposti: info@clasohlson.fi
www.clasohlson.fi
Clas Ohlson Oy, Annankatu 34–36 A, 00100 HELSINKI

GREAT BRITAIN

INTERNET

For consumer contact, please visit
www.clasohlson.co.uk and click on
customer service.
www.clasohlson.co.uk

CE RoHS



N16354